

**B-OG-302-004/FP-001
(CFP 30214), Part One**

SPECIFIC OPERATIONS

VOLUME 4

PART ONE

JUNGLE OPERATIONS

OPI: DLP

79-01-09

ISSUED ON AUTHORITY OF THE CHIEF OF THE DEFENCE STAFF

LIST OF EFFECTIVE PAGES

Insert latest changed pages; dispose of superseded pages in accordance with applicable orders.

NOTE - On a changed page, the portion of the text affected by the latest change is indicated by a vertical line in the margin of the page. Changes to illustrations are indicated by miniature pointing hands or black vertical lines.

Total number of pages in this order is 299 consisting of the following:

Page No.	Change No.
Title Page	0
A	0
i/ii to xv/xvi	0
1-1, 1-2	0
2-1 to 2-42	0
3-1 to 3-11/3-12	0
4-1 to 4-50	0
5-1 to 5-49/5-50	0
6-1 to 6-45/6-46	0
7-1 to 7-13/7-14	0
8-1 to 8-7/8-8	0
9-1 to 9-10	0
A-1 to A-12	0
B-1 to B-8	0
C-1 to C-3/C-4	0
D-1 to D-7/13-8	0
E-1 to E-6	0
F-1 to F-19/F-20	0

Zero in Change No. column indicates an original page.

FORWARD

1. B-OG-302-004/FP-001, Specific Operations, Volume 4, Part One, Jungle Operations is issued on authority of the Chief of the Defence Staff.
2. This publication is effective on receipt and should be read in conjunction with CFP 302(4) Part Two - A Soldier's Guide to the Jungle.
3. Suggestions for changes to this publication shall be forwarded through normal channels to Mobile Command Headquarters, Attention SSO Infantry.

TABLE OF CONTENTS

CHAPTER 1 - INTRODUCTION

Section 1 - Outline

General
Aim
Scope
Acclimatization
Tactical Principles

CHAPTER 2 - THE ENVIRONMENT

Section 1 - Location of World Jungles

Orientation

Section 2 - Topography

General

Section 3 - Climate

Factors to be Considered

Section 4 - Vegetation

General
Primary Jungle
Secondary Jungle
Deciduous Forest
Beach Forest
Moss Forest
Grassland
Swamp
Plantations and Cultivation

Section 5 - Habitation

People
Wildlife
Health
Communications

CHAPTER 3 - THE THREAT

Section 1 - Introduction

General

Section 2 - Enemy Characteristics

General

The Regular Soldier

The Regional Soldier

Weapons and Equipment

Section 3 - Enemy Tactics

General

Offensive Operations

Defensive Operations

The Withdrawal

CHAPTER 4 - THE EFFECT OF THE JUNGLE ON MILITARY OPERATIONS

Section 1 - General Effects on the Army

General

Visibility

Mobility

Firepower

Concealment and Cover

Protection

Obstacles

Section 2 - Intelligence

General

Sources of Information

Section 3 - Infantry

General

Principles of Employment

Firepower

Additional Equipment

Section 4 - Armour

- General
- Effect of the Environment
- Offensive Operations
- Defensive Operations
- Other Roles
- Maintenance and Repair
- Conclusion

Section 5 - Artillery

- General
- Effect of the Environment
- Jungle Employment
- Deployment
- Target Acquisition
- Command and Control
- Adjustment of Fire

Section 6 - Engineer

- General
- Improving Mobility
- Airstrips and Landing Sites
- Obstacle Crossing
- Land Clearing
- Mine Clearance
- Hindering the Enemy
- Further Tasks
- Other Considerations
- Equipment and Organization

Section 7 - Signals

- General
- Radio
- Other Methods
- Operating and Maintenance

Section 8 - Air

- General
- Air Reconnaissance
- Offensive Air Support
- Transport Support

Command and Control
Miscellaneous Tasks
Vulnerability and Maintenance

Section 9 - Administration

General
Transport
Supply
Maintenance, Repair, and Recovery
Medical
Miscellaneous Services
Local Defence

CHAPTER 5 - JUNGLE SKILLS AND DRILLS

Section 1 - In the Jungle

General
Living in the Jungle

Section 2 - Navigation

General
Navigational Limitations in Jungle
Methods of Direction Keeping
Distance
Planning of Movement

Section 3 - Tracking

General
Techniques

Section 4 - Jungle Movement

Movement on Foot
Night Movement
Immediate Action Drills

Section 5 - Obstacle Crossing

General
Basic Drills
River Crossings
Selecting Crossing Places

Section 6 - Halts

- General
- Reconnaissance
- Occupation
- Protection
- Work Period
- Routine
- Summary

Section 7 - Movement in Transport

- General
- Briefing and Preparation
- Vehicle Grouping
- Route Protection
- Route Clearance

CHAPTER 6 - JUNGLE TACTICS

Section 1 - Introduction

- General
- The Enemy
- Ground
- Time and Space
- Command and Control
- Logistics

Section 2 - Jungle Domination

- General
- Tactical Concept
- Forward Operational Base
- Conduct of Operations
- Fire Support Bases
- Command and Control
- Summary

Section 3 - Offensive Operations

- General
- Effects of the Environment
- Approach March
- Attack

Exploitation
Tactical Infiltration
Deep Penetration
Summary

Section 4 - The Attack

Introduction
The Concept of the Attack
Planning
Grouping for the Attack
Timing of the Attack
Method of the Attack
Mopping up

Section 5 - Defensive Operations

General
Principles
Preparation and Layout of Defensive Positions
Counter Attack

Section 6 - Withdrawal

Purpose
Method
Conduct of Withdrawal
Logistic Support
Summary

CHAPTER 7 - PARTICULAR OPERATIONS

Section 1 - Introduction

Patrolling and Ambushing

Section 2 - Patrolling

General
Base Line Patrols
Fan Patrols
Stream Line Patrols
Cross Grain Patrol
Patrol Technique
Reconnaissance of an Enemy Position
Fire Support for Patrols

CHAPTER 8 - NUCLEAR AND CHEMICAL WARFARE

Section 1 - Effect of Nuclear Weapons

General
Heat
Blast
Nuclear Radiation
Summary

Section 2 - Chemical Threat

General
Chemical Effects
Effect of Jungle on Protective Clothing and Equipment
Summary

CHAPTER 9 - TRAINING

Section 1 - Introduction

Aim of Jungle Training
Acclimatization
Individual Training
Unit Training
Jungle Tactics
Specialist Platoons and Supporting Arms
Battle Group Training

Section 2 - Aids to Training

Jungle Lore Lanes
Jungle Ranges
Jungle Warfare Instructors' Course
Jungle Aide-mémoire

ANNEXES

- A USE OF DOGS
- B THE COMBAT TRACKER TEAM
- C JUNGLE LORE LANES
- D JUNGLE RANGES
- E SUGGESTED SYLLABUS FOR JUNGLE WARFARE INSTRUCTORS COURSE
- F JUNGLE OPERATIONS AIDE-MÉMOIRE

LIST OF FIGURES

FIGURE	TITLE
2-1	The World's Jungles
2-2	Jungle Scenery
2-3	A Coastal Village Amongst Coconut Palms
2-4	Mangrove Swamps Often Extend Well Inland
2-5	Morning Mist Filling Jungle Valleys
2-6	The Trunks Rise to Considerable Heights Before the Appearance of Branches
2-7	Dense Undergrowth Along the Banks of Streams Hinders Movement on Foot
2-8	Fallen Trees and Thick Undergrowth Make Vehicle Movement Impracticable
2-9	Secondary Jungle
2-10	Secondary Growth on the Edge of the Jungle: Matted and Difficult to Penetrate
2-11	Spear Grass: One of the More Impenetrable Types of Secondary Growth
2-12	Bamboo Grows Rapidly
2-13	High Grass May be Interspersed with Low Trees
2-14	Another Example of Secondary Jungle Showing Various Grasses and Ferns
2-15	Swamp can Occur in Open Clearing or -
2-16	In the Semi-darkness of the Jungle
2-17	Moving Through Swamp to Retrieve Supplies: Note the Parachute Caught in the Trees
2-18	Movement Through Swamp Made Difficult by Water, Mud, and Tangled Vegetation
2-19	The Mangrove - Its Tangled Roots are Found Above and Below the Water Line
2-20	The Mangrove - Cover is Very Good
2-21	Cultivation
2-22	A Rubber Plantation: Well Tended and Devoid of Undergrowth
2-23	Oil Palms
2-24	Visibility is Unrestricted and Cover is Poor
2-25	Flooded Rice Showing the Bunds Which Divide Individual Fields
2-26	Improvised Raft
4-1	Locally Constructed Bridge
4-2	A Helicopter LS in Primary Jungle Amongst Trees 60 Metres High
5-1	A Shelter Made From Elephant Grass
5-2	A Fallen Tree Can Provide a Useful Path
5-3	Navigation is Made Difficult by Limited Visibility and Streams, Like This One, May Not be Marked on the Map
5-4	Route Taken by a Patrol to Avoid an Obstacle
5-5	Tracking - Circular Search
5-6	Tracking - Box Search
5-7	Tracking - Zig-zag Search
5-8	Immediate Ambush Drill Front
5-9	Platoon Occupation of a Halt Position
5-10	Clearing Patrols
7-1	A Reconnaissance Patrol Following a Stream Bed

7-2	Base Line Patrols
7-3	Fan Patrols
7-4	Stream Line Patrols
7-5	Cross Gain Patrol
7-6	Fire Controller
A-1	An Infantry Patrol Dog

CHAPTER 1
INTRODUCTION

SECTION 1

OUTLINE

GENERAL

1. B-OG-302-004/FP-001, Jungle Operations, is the first of two parts dealing with the jungle. The second is CFP 302(4), Part Two - A Soldier's Guide to the Jungle. The former provides a guide for commanders from formation to section level while the latter sets out skills and drills which will be of use to all ranks, as individuals.

AIM

2. The aim of jungle operations is to defeat the enemy.
3. The aim of this manual is to give guidance on the tactics and techniques which must be used by commanders when deployed in a jungle setting.

SCOPE

4. This manual covers a description of the jungle, an outline of the threat, and then considers the effects of the jungle on land operations. An introduction to skills and drills (featured in more detail in Part Two; explanation of tactics, training, and administration follow.

ACCLIMATIZATION

5. It is essential that troops be acclimatized before being committed to operations in the jungle. This process takes time - time for the body and time for the mind. Training under jungle conditions will help to reduce the length of this period. As a guide, two weeks is considered to be the minimum time for acclimatization.

TACTICAL PRINCIPLES

6. The general principles, fundamentals, and methods of operating do not change substantially, no matter what terrain is encountered or under what climatic conditions operations are conducted.
7. This manual deals with specific differences to operations and administrative procedures caused by the terrain, climate, and enemy threat.

CHAPTER 2

THE ENVIRONMENT

SECTION 1

LOCATION OF WORLD JUNGLES

ORIENTATION

1. Almost one third of the earth's tropical zone is an area of high temperature and humidity where the natural vegetation is largely rain forest. This area, which also includes deciduous forest, swamp, and tropical grasslands, makes up the jungle, and is to be found principally in South East Asia and Latin America. It is mostly underdeveloped, with poor communications and small and often primitive indigenous populations. A map showing the world's major jungle areas is in Figure 2-1.

2. South East Asia. The oriental jungle is distributed over a wide area and many countries. It extends from the foothills of the Himalayas in the north to Australia in the south, east to Fiji and west to India; it is thickest and most extensive in Malaysia, Indonesia, and New Guinea and also covers substantial areas of Thailand, Laos, Cambodia, Vietnam, and the Philippines. Although in these areas large tracts of virgin rain forest have been cleared for the development of towns or the growth of crops, the jungle itself is still very extensive.

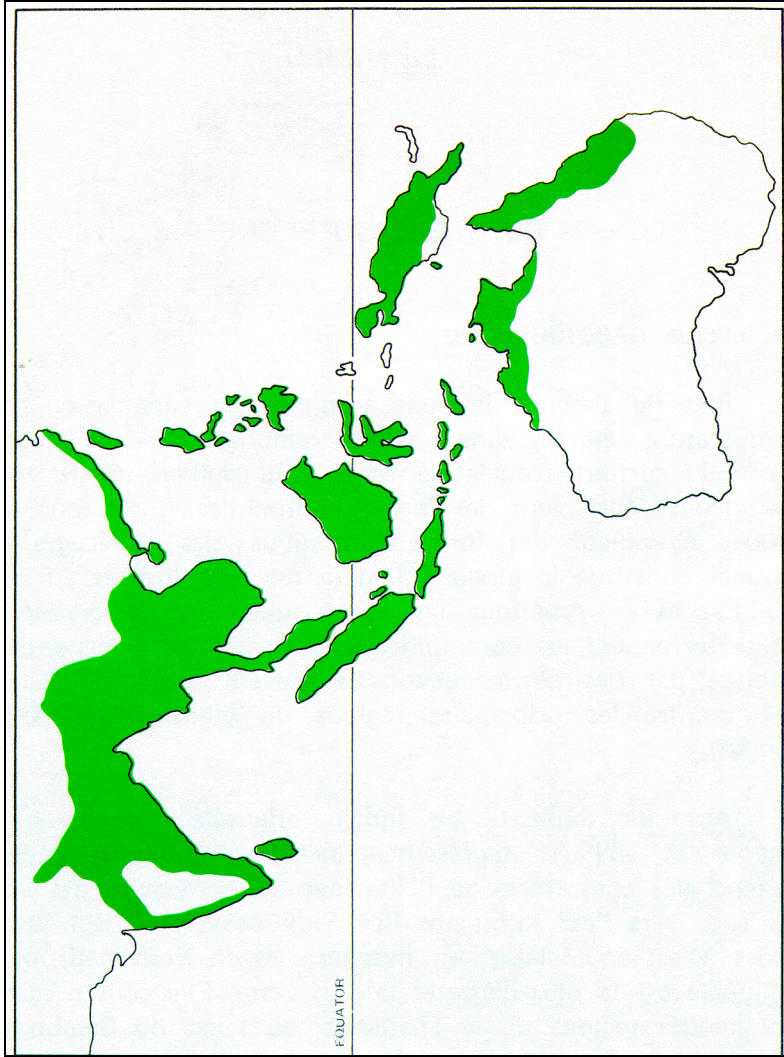

Figure 2-1 (Sheet 1 of 2) The World's Jungles

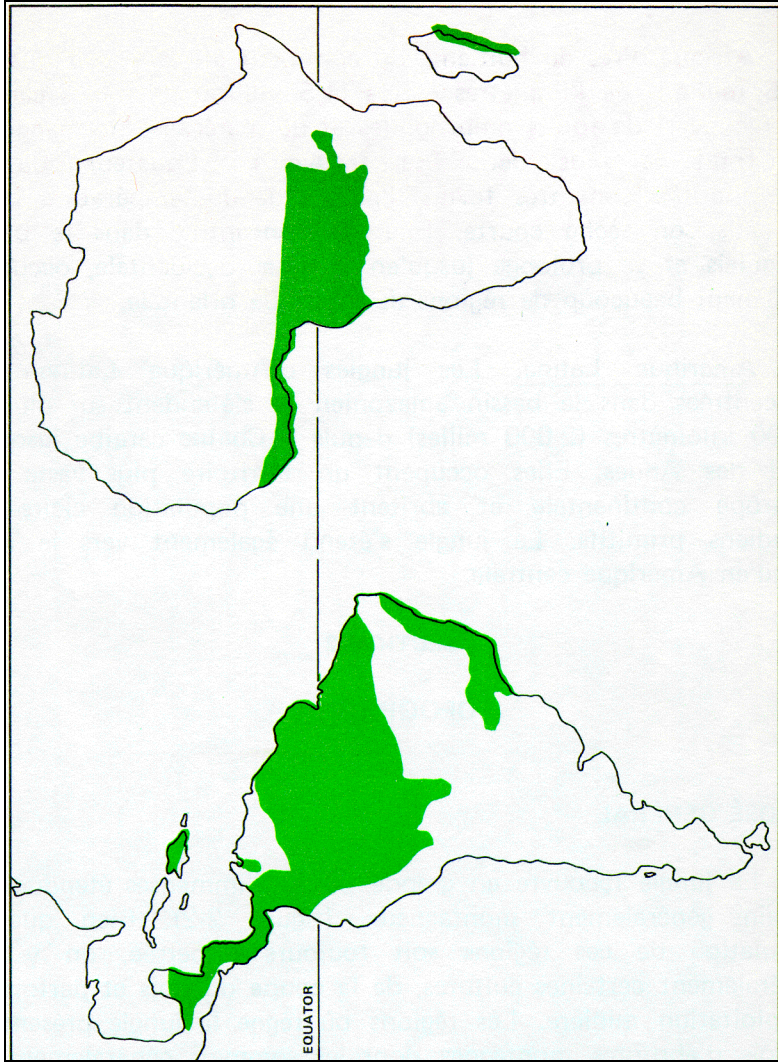

Figure 2-1 (Sheet 2 of 2) The World's Jungles

3. Africa. About one eighth of the continent of Africa, or some 3.75 million square km (1 1/2 million square miles), is made up of rain forest and mangrove swamp. The densest jungle is found astride the equator, where rainfall is highest, the temperature range small, and the dry season short; it is Centred on the Congo basin and extends into West Africa, but is also found in many parts of East Africa.

4. Latin America. The Latin America jungles are centred on the Amazon basin and extend more than 3200 km (2000 miles) from the Caribbean to the base of the Andes. They comprise a land mass larger than continental Europe and are sparsely inhabited by primitive Indians. Jungle also extends north into Central America.

SECTION 2

TOPOGRAPHY

GENERAL

5. The majority of jungle covers extensive tracts of generally hilly country (see figure 2-2). Although such areas are always sparsely populated, there is usually some cultivation and timber extraction and mining may be practised. Jungle regions sometimes include rugged mountains, frequently with razor backed ridges abruptly intersected by deep, steep sided valleys. Some mountain chains may reach 3 000 metres or more and go above the tree line to areas where temperatures drop rapidly at night and may well freeze.

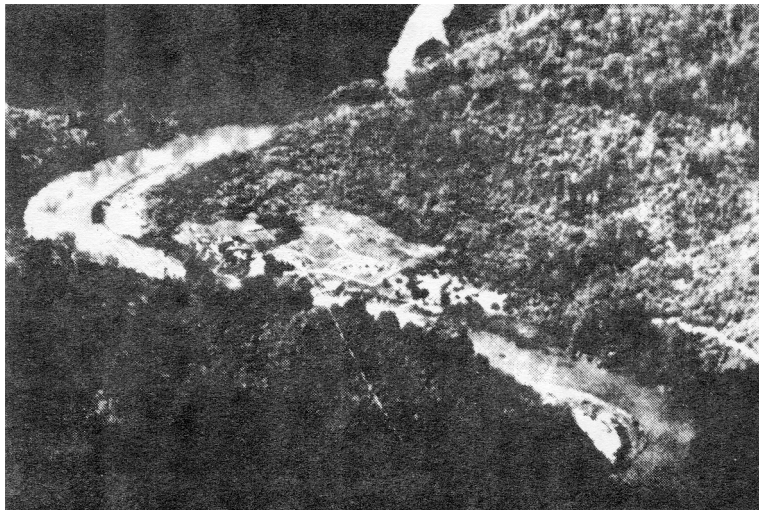

Figure 2-2 Jungle Scenery

6. Coastal Areas. The coastlines of jungle areas (see figure 2-3) include a wide variety of terrain from open beaches to dense mangrove swamps which sometimes extend for a considerable distance inland. Because of the undeveloped interior, good ports are infrequent; maintenance across beaches may be made hazardous by tropical storms and the presence of physical barriers such as coral reefs. The coastal belt behind the beaches may vary from flat alluvial plains to narrow strips with foothills rising abruptly close to the shore. In flat coastal regions and near deltas, the area is seldom well drained, resulting in numerous slow moving streams, many of which finally flow into swamps with tidal effects often evident well inland. (See figure 2-4.) The rivers are frequently the only existing means of surface communication with the interior.



Figure 2-3 A Coastal Village Amongst Coconut Palms

7. Plains. Where extensive plains are found, these are usually in the form of river basins, deltas, or high plateaux. The rivers often vary widely according to the season and where monsoon conditions prevail, they may rise quickly and flood easily. Rice cultivation is a major feature of low-lying plains, it requires prolonged flooding and the construction of numerous dikes or bunds, which give the landscape a patterned effect and hinder movement.

8. Population. The main centres of population are generally in the plains and on the coastal strips where crops can be raised and communication is easiest. Jungle areas become more sparsely populated as communications become more difficult and in the interior, the villages are likely to be small and infrequent and the people shy and primitive.

9. Drainage. The large rainfall in jungle areas produces swift flowing streams in the hills often bordered by steep rocky banks and with frequent rapids. These streams drain into sluggish and meandering rivers in the plains, which flood quickly and often take a long time to subside.

10. Soils. The soils of the jungle areas vary widely but they seldom provide a good surface for wheeled traffic, especially during rainy periods, although laterite which makes an excellent road building material occurs naturally in several jungle regions.

11. Natural Resources. The most plentiful natural material in jungle regions is timber. Hardwoods such as teak are the most durable but the softer woods found in most jungle are excellent material for the construction of huts, shelters, bridges, and rafts and for the surface of corduroy roads. Vines are plentiful and strong and provide a reasonable substitute for rope.

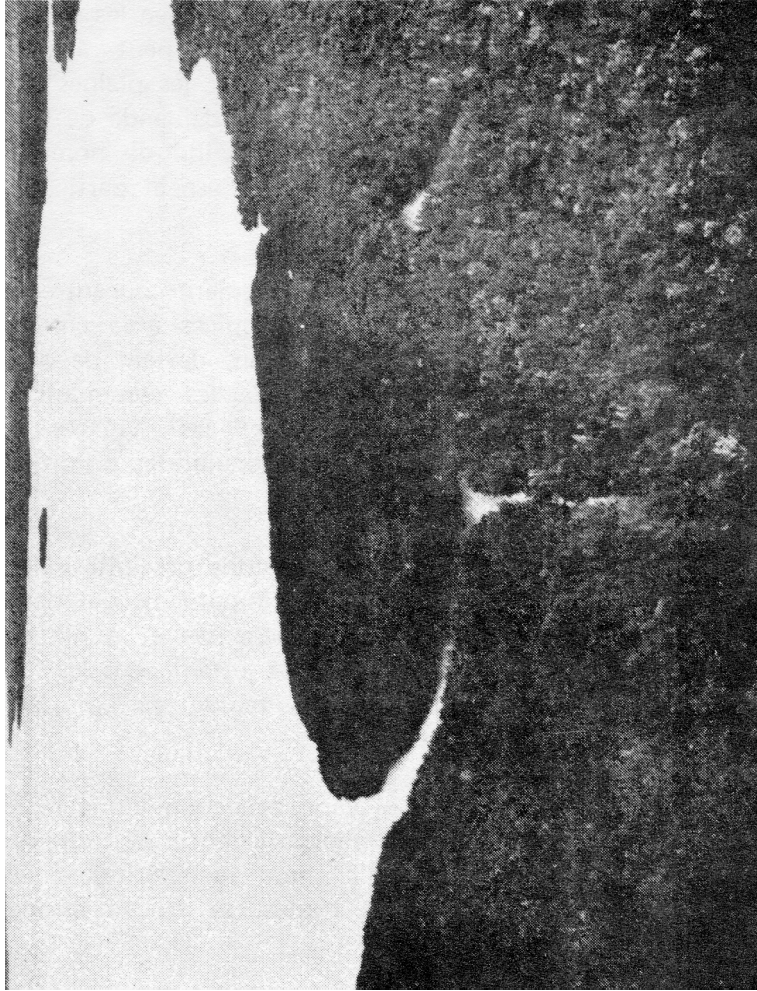

Figure 2-4 Mangrove Swamps Often Extend Well Inland

SECTION 3

CLIMATE

FACTORS TO BE CONSIDERED

12. On or near the equator, atmospheric pressure is fairly uniform throughout the year, so that the seasons are almost indistinguishable. Away from the equator, though still within the tropics, cyclic wet and dry seasons occur and temperatures are less uniform. However, in both equatorial and sub-tropical regions, the climatic features of the jungles are high temperatures, heavy rainfall, and oppressive humidity during the greater part of year.

13. In most equatorial jungle areas, the mean temperature remains constant within a few degrees throughout the year and the daily range seldom varies by more than 10 °C. Further away from the equator, the daily and seasonal variations increase appreciably. Greater variations of temperature occur at high altitude, where it can be cold, and in areas of open savannah and fern which trap the heat and can build up temperatures to over 37 °C. Relative humidity in rain forest is seldom low and often rises to about 90 per cent (near saturation) in monsoon conditions and at night.

14. Tropical rainfall is characteristically heavy and is often accompanied by thunder and lightning. It can convert dry water courses and small streams into raging torrents, while the waters of small rivers can rise at an alarming rate and the larger rivers can inundate wide plains in a few hours.

15. The total annual rainfall in jungle areas is rarely less than 150 cm. In parts of Burma and some of the more mountainous parts of Borneo, it is; over 500 cm. The seasonal distribution of rain varies with latitude; at the equator, the general pattern is one of rainfall throughout the year, whereas dry and wet seasons become more distinctive further north and south.

16. The prevailing wind conditions which cause variations between the summer and winter months produce predictable types of weather; and dry season where the wind blows from the direction of a large land mass, and a very wet one when it comes off the ocean, In much of South East Asia, for example, the North East or winter monsoon is associated with dry weather from its long land trek across China, and the summer or South West monsoon with wet weather due to its route across the Indian Ocean. Malaysia is, however, an exception in that the North Easterly winds cross the South China Sea and give wet weather in the winter months, whereas the South Westerlies are interrupted by the mountains of Sumatra and Borneo and produce generally drier weather. A monsoon which gives a rainy season on one side of an island or peninsula may well produce dry weather on the other. Each region of the world has its particular characteristics which should be studied in advance of operations.

17. Surface winds usually follow the general direction of the prevailing winds with speeds generally lighter than in temperate or desert areas, averaging 2, to 5 knots on coasts, and normally affecting only the roof of the forest. Temperature variations between land and sea may produce breezes which cancel out the prevailing wind, producing unusual local conditions in

places and strong gusts during storms. Very high wind speeds can occur in areas affected by typhoons or cyclones.

18. Tropical days and nights are nearly equal in length and the transition between them is rapid giving only a short period of twilight. Although the equator is frequently more cloudy than the areas north and south of it, the light, even when the cloud is predominant, usually remains good and is often brighter than it appears.

19. In general, cloud in inland areas near the equator is at a maximum in the afternoon, while coastlines tend to experience more cloud during the night than the day. Early morning mist often occurs over inland jungle, swamp areas, and valleys, but generally disperses during the morning. (See figure 2-5.) Low cloud at about 150 m occurs during the more violent storms and mountainous areas are seldom cloud free.



Figure 2-5 Morning Mist Filling Jungle Valleys

20. Good visibility, over 15 and sometimes up to 180 km, is usual in most jungle regions, except for the hours around sunrise over rivers, swampy valleys, and low lying forest. Thunderstorms can cause rapid local deterioration of visibility which may even approach nil in exceptional conditions. In hilly areas, mist may be persistent during and after rain, and in the valleys steam from the jungle after heavy storms can produce fog at tree top level.

21. Heavy thunderstorms accompanied by brilliant lighting are not uncommon in jungle areas but they are generally of short duration and are most prevalent in the mountainous regions.

22. Tropical cyclones (typhoons or hurricanes) occur from time to time in certain regions, usually towards the end of the summer months. They develop over the sea and can be a threat to coastlines and narrow peninsulas and isthmuses. Heavy rain and high winds up to 100 knots sometimes occur near the path of a cyclone, which can have an effective diameter of between 160 km and 480 km (100 and 300 miles). A cyclone moving over areas will uproot all but the stoutest trees and create chaotic ground conditions.

23. In the dense area of primary jungle, the canopy provides a cover within which the jungle develops its own microclimate where conditions on the ground may differ appreciably from those prevailing above tree level. The canopy not only intercepts and redirects a considerable

proportion of the rain, but it also shelters the jungle from the wind thus preventing sharp rise and falls in temperature; it also diffuses the light and creates a permanent twilight.

SECTION 4

VEGETATION

GENERAL

24. The heavy rainfall and high temperature encourage rapid and continuous growth and a consequent profusion of vegetation. The type of vegetation determines the character of the jungle.

PRIMARY JUNGLE

25. Primary jungle is the original growth of tall and profusely leaved evergreen trees which occurs naturally in lowland tropical areas where the annual rainfall averages 200 cm or more. Humidity remains high at all times. The trees usually grow in three storeys, their crowns forming successive layers at different heights. The first storey consists of trees some 10 m high, which together with a second storey of trees up to 25 m forms the thick canopy which keeps out the sun; the third storey consists of the tallest trees, some being as high as 60 m but these are fairly sparse. The trunks often rise to considerable heights before the appearance of branches (see figure 2-6), but the buttress roots are a common feature at the foot and a tangled growth of lianas and creepers and parasitic plants hang down from the trees. The jungle floor is comparatively free of undergrowth and the soil is dark, wet, and of poor quality. The field of view in the best conditions will seldom exceed 50 m.



Figure 2-6 The Trunks Rise to Considerable Heights Before The Appearance of Branches

26. Movement on foot through primary jungle is generally fairly easy as the trees are well spaced: the best going being along crests or ridges. The worst obstacles are provided by streams or river banks where dense undergrowth may occur (see figure 2-7). Movement of wheeled transport is very difficult if not impossible. Where flat ground and wide spacing of the trees

might permit the passage of vehicles, the roots, fallen trees, creepers, and the wet and soggy floor make such movement impracticable (see figure 2-8). Cover from the air is complete though felled trees make a noticeable gap in the otherwise unbroken roof of the forest, and any constructional work necessitating clearance can be easily detected.



Figure 2-7 Dense Undergrowth Along the Banks of Streams Hinders Movement on Foot

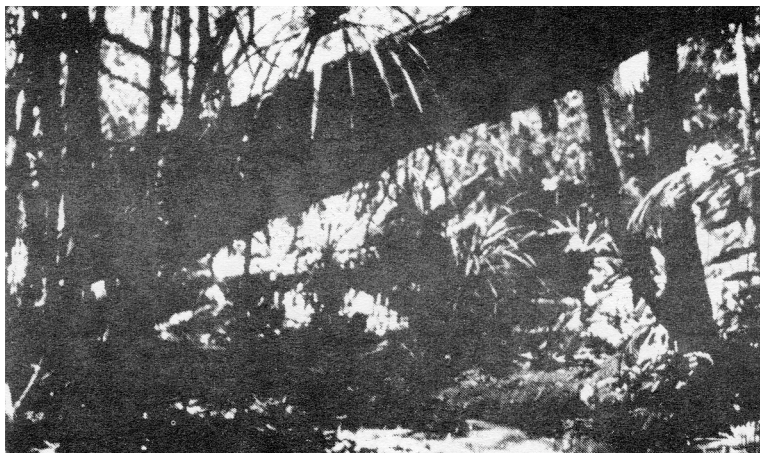

Figure 2-8 Fallen Trees and Thick Undergrowth Make Vehicle Movement Impracticable

SECONDARY JUNGLE (see Figure 2-9)



Figure 2-9 Secondary Jungle

27. Wherever primary jungle or deciduous forests are cleared and later abandoned, a secondary growth, known as secondary jungle, results. Due to exposure to sunlight, the bare areas are rapidly overgrown by weeds, grasses, ferns, canes, thorns, and shrubs, which reach a height of about 2 to 3 m within a year. Secondary jungle is also common on the edge of primary jungle where the light can enter, encouraging a thin, dense belt of undergrowth (see figures 2-10 and 2-11).



Figure 2-10 Secondary Growth on the Edge of the Jungle: Matted and Difficult to Penetrate



Figure 2-11 Spear Grass: One of the More Impenetrable Types of Secondary Growth

28. Movement through secondary jungle is very slow as it is virtually impenetrable to men on foot and, while tanks can sometimes crush their way through, the growth of woody species and the presence of old felled logs, stumps, and protruding roots which often litter the floor create conditions impassable for wheeled vehicles. Visibility is seldom more than a few metres. The cover available depends on the growth but even at advanced stages it may be difficult to conceal vehicles due to the scarcity of large trees.

29. Bamboo grows rapidly in secondary jungle (see figure :2-12) and at certain altitudes produces a dense mass of canes between 5 and 20 m high and up to 15 cm in diameter, which interlock to create formidable obstacles to any type of movement. In some areas, bamboo grows in clumps which permit movement on foot between them, through the area will probably be impassable to vehicles until routes are cleared. Movement through all forms of bamboo tends to be extremely noisy especially when it is dry, as the stems are brittle and resound when cut. Amongst older growth, the ground is also covered with husks. Maximum ground visibility will seldom be greater than 20 m and cover from the air can be complete amongst mature species.

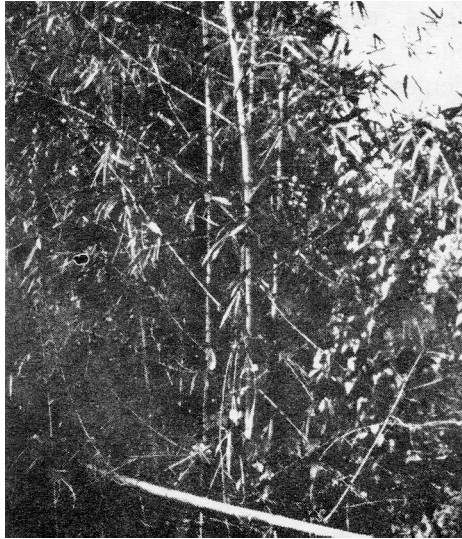

Figure 2-12 Bamboo Grows Rapidly

DECIDUOUS FOREST

30. Deciduous forest occurs in areas which have a dry season lasting between three to six months, the trees are not as dense or tall as in primary jungle and some sunlight filters through the canopy, encouraging a more profuse undergrowth. A proportion of the trees shed their leaves for a month or more at different times in the dry season, when fires in the undergrowth are not uncommon leading to local openness of the forest floor.

31. In the wet season, movement is generally more difficult than in primary jungle, because of the amount of undergrowth but in the dry season it is easier because the forest floor is firmer and the trees are more widely spaced. However, transport can seldom negotiate deciduous forest without considerable engineer effort.

32. Visibility varies according to the time of year. In the wet season, when the trees are in leaf, it is unlikely to be more than 30 m. Cover from the air is good while the trees are in leaf and at other times, it is little better than that provided by an open wood.

BEACH FOREST

33. Beach forest is used to describe coastal vegetation found on dry ground along the rear of sandy beaches subject to neither tidal nor fresh water flooding. It grows in strips to a depth of little more than 100 m and consists mainly of casuarina trees which grow to a maximum height of 25 m. Beach forest is far less dense than rain forest and movement on foot is easy as the forest is dry and free from undergrowth; although the density of the trees generally restricts the movement of transport to small vehicles. Cover from the air is good but ground cover is sparse and visibility can be about 50 m.

MOSS FOREST

34. Moss, or mountain, forest is found in some equatorial areas at high altitudes, usually above 2 000 m (but occasionally as low as 1 000 m), and sometimes mixed with pine forests in monsoon areas subject to a dry season. The forest consists of a single storey of stunted, distorted trees, usually about 6 m high but sometimes as high as 20 m. The tree trunks and branches are covered in moss, which is festooned from bough to bough, creating a dense canopy through which little light filters. Undergrowth other than ferns is uncommon and animals and birds are generally scarce.

35. The forest floor is often covered by a moss blanket up to 1 m thick or by heavy slime which may hide ravines and rocks. At the higher altitudes, the trees are so stunted that it is impossible to walk under the branches. Although men on foot can move through the forest, progress is slippery and slow and the air is usually cold and still, movement by transport is out of the question. Visibility is severely restricted, seldom exceeding 15 m, and cover from air and ground observation is excellent.

GRASSLAND

36. Tropical grasslands are of two main types, natural growth on plains or plateaux and secondary growth on cleared land.

- a. The natural growth, known as savannah, occurs in open country or high plateaux where there is a long dry season and soil is suitable. Low trees may occur singly or in small scattered groves, while the grasses range from a metre or 2 in height in the more arid parts to an occasional 5 m in well watered areas. (See figure 2-13.) The grass itself may be sharp edged and dense, and, although unpleasant to traverse, it offers less resistance to movement of either men or vehicles than most other tropical growth. Nevertheless, progress is tiring due to the trapped heat and the high humidity. The daily temperature range in such regions is far greater than in the jungle and as the dry season continues, fires are not uncommon. Visibility varies according to the height of the grasses but cover from the air is generally poor. Men can take cover under bushes and trees, but these are usually too small to conceal vehicles effectively.



Figure 2-13 High Grass May be Interspersed with Low Trees

- b. Clearings in the jungle where grass has established itself as predominant secondary growth are generally thicker, and more matted than open savannah. (See figure 2-1-4.) The grass tends to be tangled with other plants and interspersed with secondary jungle in stream beds and ravines. Ease of movement, visibility, and cover depend on local conditions.



Figure 2-14 Another Example of Secondary Jungle Showing Various Grasses and Ferns

SWAMP

37. Swamps are common place in tropical jungle in all low laying areas where there is water. They produce a formidable combination of terrain and vegetation through which the going is extremely difficult (see figures 2-15 to 2-18). The most common forms to be found are as follows:



Figure 2-15 Swamp Can Occur in Open Clearing, or -



Figure 2-16 In the Semi-darkness of the Jungle



Figure 2-17 Moving Through Swamp to Retrieve Supplies: Note the Parachute Caught in the Trees



Figure 2-18 Movement Through Swamp Made Difficult by Water, Mud and Tangled Vegetation

- a. Mangrove. Mangrove swamps occur in coastal areas subject to tidal flooding, around river mouths, deltas and inlets, along shallow bays or small islands, and upstream as far as the tidal influence is felt. The mangrove thrives in both shallow and deep mud (see figure 2-19) and it varies in height from shrubs of a metre or 2 to trees of up to about 12 m high. Its tangled roots are found both above and below water level and movement is possible only on foot, except where the few deep water channels which run through it are navigable by small boats. Visibility is generally restricted to a few metres and cover from both ground and air observation is very good. (See figure 2-20.)

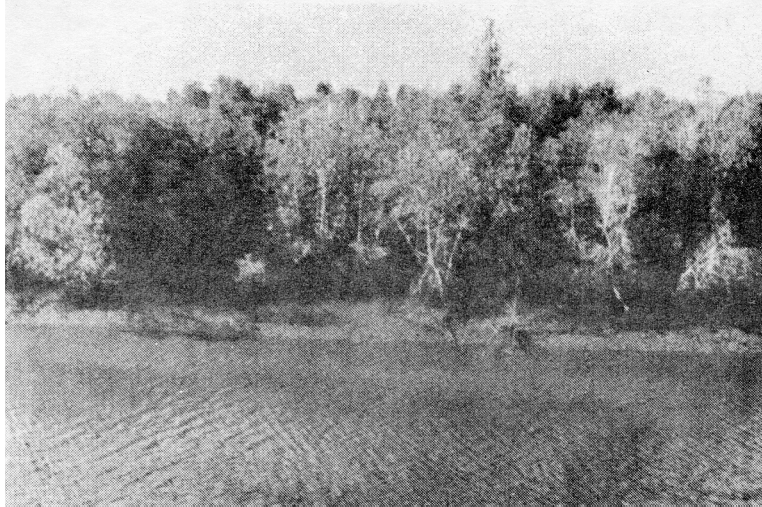

Figure 2-19 The Mangrove - Its Tangled Roots are Found Above and Below the Water Line

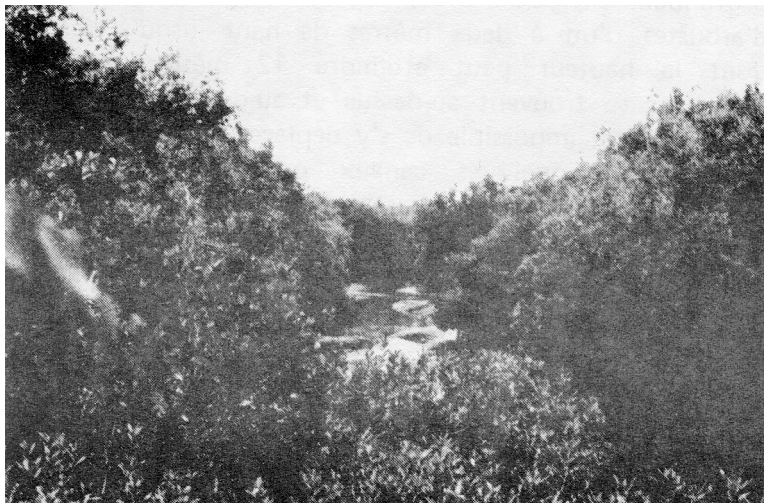

Figure 2-20 The Mangrove - Cover is Very Good

- b. Nipa. Nipa palm is usually found above mangrove swamp and often merges with it at a point where salt is replaced by brackish water. It is also found along estuaries and tidal rivers where the water is fresh at low tides. Although usually confined to a narrow belt of ground, it occasionally spreads over extensive areas ousting other species. The mature palm seldom exceeds 6 m in height and consists of a number of stiff fronds which grow a short stem, often so short as to be unnoticeable. The palms grow close together in liquid mud and the root systems are tenacious enough for them to survive in quite rapid currents. Foot movement through the swamp is very difficult, as the fronds form a formidable barrier through which it takes considerable strength to force a passage even when the floor is dry; it is best avoided altogether when flooded. Visibility is restricted to a few metres, and cover is complete.

- c. Sago. The sago palm is extensively found in freshwater swamps growing in liquid mud; when mature it reaches a height of about 15 m with a trunk 50 cm in diameter. Movement is extremely difficult through the dense stand of trunks, suckers, and seedlings, although paths may already exist. Even when such a clearing has been made, logs or some other improvised surface material need laying to enable vehicles to move. Visibility is restricted to a few metres and cover is complete, though cleared tracks will usually show up distinctly from the air.
- d. Fresh Water Swamp. This occurs in low-lying inland areas. It may consist of a dense tangled network of trees and thorny undergrowth, or alternatively reeds and grasses with occasional short palms growing in slow-moving or stagnant water or in semi-liquid mud up to a metre deep sometimes covered in a layer of peat. Vehicle movement is virtually impossible, and roads can only be constructed after clearance and drainage. Visibility varies from about 5 to 20 m and cover is complete until clearance has started.

PLANTATIONS AND CULTIVATION

38. Cultivation in the jungle (see figure 2-21) varies from the primitive efforts of the more remote tribes, through the more ordered and extensive but still simple agriculture of the bigger villages to large scale commercial plantations of coffee, rubber, tea, cocoa, etc. The crops concerned can be divided into four main categories:



Figure 2-21 Cultivation

- a. Tree Crops. These include coffee, rubber (see figure 2-22), coconut, oil palm (see figure 2-23), cocoa, etc. The trees are planted at regular intervals in well spaced lines and the ground is normally free from undergrowth, though in small holdings the trees may be more closely spaced and the undergrowth uncleared. Movement on foot is not difficult, and moderately-sized vehicles can often traverse plantations unless there are wide drainage ditches. Well developed track and road systems, normally constructed of beaten earth but sometimes of laterite, are maintained on the larger estates, with wooden bridges

of limited strength. Visibility is generally extensive along the rows and restricted in other directions. Cover from the air depends on the type and height of the trees; cocoa and coffee trees, which are small, only provide cover for vehicles if the trees are mature, but as a rule, cover is good in all plantations except coconut.

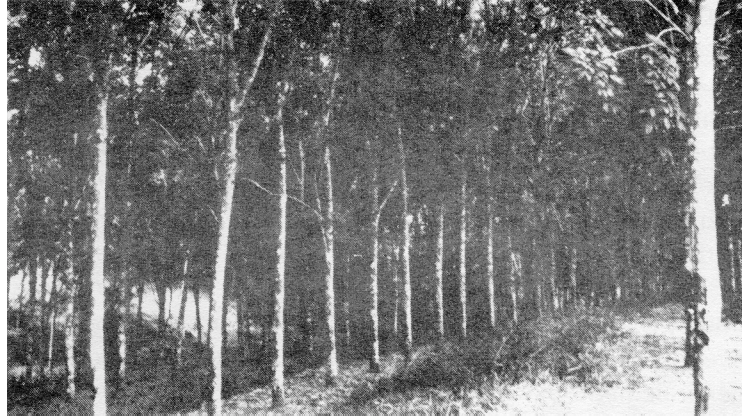

Figure 2-22 A Rubber Plantation: Well Tended and Devoid of Undergrowth



Figure 2-23 Oil Palms

- b. Bush Crops. These include plantations of tea, cotton, and tobacco, the general characteristics of which are similar to those of vineyards or currant bushes. They also are found in a regular pattern but being smaller than tree crops they are planted closer together, rows usually being no more than about 2 m apart with individual plants fairly closely spaced. Foot movement is free and tracked vehicles in particular can negotiate the bushes easily. Visibility is unrestricted by the bushes, and cover is poor. (See figure 2-24.)



Figure 2-24 Visibility is Unrestricted and Cover is Poor

- c. Dry Crops. Crops such as maize, millet, sugar, and certain types of rice come into this category. They present no obstacle to movement, and provide some individual cover at ground level.

- d. Wet Crops. By far the most important crop is rice, widely grown in all hot, wet tropical areas. (See figure 2-25.) The ricefields are flooded by about a foot of water for five to ten months of the year, but when dry they become hard and after harvesting are covered with a low stubble. Earth dikes or bunds up to a metre high and sometimes as wide as 6 m separate individual ricefields, which may vary greatly in size and are sometimes constructed with great ingenuity on slopes in the hilly areas. Ricefields provide no cover from view from either ground or air, though the bunds can give limited protection; vehicle movement over flooded rice is difficult, but when the fields are dry, movement is restricted only by the bunds.



Figure 2-25 Flooded Rice Showing the Bunds Which Divide Individual Fields

SECTION 5

HABITATION

PEOPLE

39. Most jungle areas are sparsely inhabited by an indigenous population which, if friendly, can be of great assistance and, if hostile, a serious threat. The winning of the hearts and minds of the people can play a vital part and it is therefore important that officers and soldiers should familiarize themselves with the customs, habits, and taboos of the local inhabitants. It is also desirable that units operating in such areas are provided with interpreters to enable them to communicate with local inhabitants.

40. Native populations can often provide useful intelligence and they are a source of manpower. Care is needed in screening and selection before employing them in any military capacity:

- a. Scouts and Trackers. These can be employed as integral elements of a military force by using their special skills for finding, following, or maintaining contact with the enemy, especially when the latter is on the move.
- b. Guides. Even in well mapped regions, there is a need for guides. They can provide advice on going and obstacles from which rates of movement can be assessed. They can also assist in liaison with the native population.
- c. Porters. The value of native portage in carrying heavy loads such as ammunition through jungle vegetation needs little emphasis. Their employment is examined further in Chap 4, Sect 9.
- d. Construction Labour. Unskilled native labour employed on such tasks as road building and maintenance can ease the strain on engineering manpower and release skilled military labour for more difficult or specialist work.
- e. Guerillas. The use of friendly guerillas in jungle warfare can play a significant part in distracting the enemy's attention and dissipating his strength. The type of tasks undertaken will depend on the strength, experience, skill, and reliability of a guerilla force, but uses include reporting on enemy activities and dispositions, conducting raids and ambushes, securing landing sites, and assisting deep penetration forces. They can also be valuable in spreading false rumours to the local population with a view to misleading the enemy.

WILDLIFE

41. Wildlife abounds in the jungle though it is rarely seen because of the dense cover. Ants, leeches, and mosquitoes infest the area, while in the canopy itself live a wide variety of birds and animals, the most common of which are monkeys; and squirrels. Some insects and reptiles such

as pythons, anacondas, lizards, tortoises, and scorpions are unusually large. On the ground, live a number of animals ranging from elephant to mouse deer, one of the most common being wild pig. The majority of jungle creatures avoid men, will not attack unless frightened, and so do not present a significant hazard to troops on operations.

HEALTH

42. The Threat. The climate, vegetation, insect life, and a number of endemic diseases all pose a considerable threat to health in the jungle. Not only is the soldier vulnerable to illness and disease to a greater extent than in other climates, but the difficulty of moving a sick or wounded man to an area where he can be properly treated is increased by the nature of the terrain.

43. Acclimatization. The marked difference in the climate found in the jungle from that of Europe means that troops who are not already acclimatized must become so before they are fully effective. The time required for this varies with individuals, the overall physical state of a unit, previous experience, and many other factors, but it is an important point which must always be considered in planning and preparations. A special quality of physical and mental stamina is required for jungle operations, and the individual soldier cannot be expected to adjust to these markedly different circumstances immediately.

44. Diseases. The majority of diseases prevalent in the jungle originate either from bites or infected food and water. The mosquito transmits malaria, yellow fever, dengue fever, and some forms of encephalitis; a very small mite spreads scrub typhus and in the grasslands of Africa, the tsetse fly spreads sleeping sickness.

- a. Diseases transmitted by infection include typhoid and paratyphoid fever, bilharzia, hepatitis, dysentery, and leptospirosis.
- b. Skin infections are likely to occur on any exposed cut or wound, on the feet, hands, and the parts of the body most prone to sweating. They are caused by various types of fungi which flourish in hot wet conditions.
- c. Virulent forms of venereal disease are common even in remote native villages.

45. Precautions. Most disease can be avoided if the right precautions are taken. Early in the Burma campaign during World War II, casualties from malaria and dysentery were equivalent to the loss of a division every two months, but by the end, the total sick rate of British troops was hardly any higher than in the United Kingdom. The main reason for the improvement was the high priority given to health discipline by commanders. Modern medicine has done much to reduce the danger, but health figures still provide an accurate reflection of a unit's state of discipline and an indication of its operational efficiency.

COMMUNICATIONS

46. General. Jungle areas lack good communications and even in the more accessible areas road, rail, and airfield facilities are limited.

47. Roads and Railways. Outside the main centres of population, most of the few roads which exist are of fair weather category only, and thus liable to interruption by floods or landslides, few bridges being wide enough or strong enough to take heavy loads. In the denser areas of jungle, roads and tracks are often only suitable for one-way traffic and a tarmac highway providing an all weather route through an area of operations will be exceptional.

48. Waterways. Water transport is an important means of movement for local inhabitants along both the coast and the extensive river systems inland, and native craft are generally plentiful in most inhabited areas. There are few vehicle bridges over waterways; foot bridges are more common and these may restrict movement on the water. Port facilities are generally limited and seldom able to handle heavy equipment: any substantial increase in handling capacity only being achieved by opening up secondary ports and using over-the-beach techniques.



Figure 2-26 Improvised Raft

49. Air. The difficulty of moving by land and water increases the value of air transport. Airfields are rare but commercial or missionary strips which can be used by light aircraft may sometimes exist. Where there are airports with modern aids, these are likely to be near major cities and remote from operations taking place in the jungle.

CHAPTER 3

THE THREAT

SECTION 1

INTRODUCTION

GENERAL

1. The wide dispersion of the world's jungles precludes the precise identification of a jungle enemy. However, some sort of picture is necessary as a background against which our own tactics and methods of operation can be developed, and as a setting for training.
2. Allied experience illustrates the wide varieties of threat and the many different types of enemy which may be encountered. Examples of these are the Japanese in the Pacific and South East Asia in World, War II, Chinese terrorist bands in Malaya, Mau Mau in Kenya, civil war in the Congo, insurrection in British Guiana, and a variety of communist guerilla movements in Indo-China culminating in the Vietnam conflict.
3. One common feature has been the enemy's dependence on Soviet or Chinese types of weapons and equipment, which, although they have sometimes been supplied direct, have also been manufactured or redistributed by other communist and East European countries. This is a pattern which will probably continue.
4. The four main types of operation in a tropical setting in which troops might be involved in the future are best illustrated by these examples:
 - a. Overt armed aggression by the regular forces of one nation against another. An example is the Indonesian confrontation.
 - b. Revolutionary operations supported by an outside power with arms and formed units of troops. An example is North Vietnamese operations in South Vietnam.
 - c. Revolutionary operations where the dissidents receive arms and assistance but not formed bodies of troop from an outside power. Examples are the early stages of communist activity in Laos, Cambodia, North-East Thailand, and the Viet Cong in South Vietnam.
 - d. Guerilla type operations within a country directed against the established government with a view to seizing power. Examples are the Mau Mau and the terrorism in Malaya.
5. The threat that is studied in this chapter is that presented by an enemy likely to be engaged in the type of operation where formed bodies of troops are used, ie, equating to para 4a and b. The purely guerilla threat (para 4c and d) is covered in Counter Revolutionary Operations.

SECTION 2

ENEMY CHARACTERISTICS

GENERAL

6. The location of the world's jungles implies an Asian, African, or Latin American enemy who is most likely to draw his inspiration from revolutionary left-wing politics and his material aid from a communist country. The individual soldier is probably relatively uneducated and deeply influenced by political indoctrination; if he is in a regular unit he (or at least his leaders), is likely to be fanatically dedicated to a cause.

7. Most countries in the jungle areas of the world are undeveloped and unable to afford large peacetime armies. They therefore resort to large scale conscription into regional bodies of troops to meet an operational need.

THE REGULAR SOLDIER

8. The regular soldier is a term used to describe a man who has been conscripted into the regular army of his country and who wears a distinguishing uniform. He is likely to be of tough peasant stock, well trained in basic tactics, and possibly with considerable operational experience. He receives a thorough infantry training whether he is an infantryman or not. In particular, he is likely to be:

- a. Adept at the use of ground and able to conduct long marches at speed over difficult terrain.
- b. Cunning and stealthy, well versed in the art of camouflage and concealment, and capable of ambush and deception techniques.
- c. Good at rapid and prolonged digging.
- d. Brave, determined, and often fanatical in both attack and defence.
- e. Able to exist for long periods on meagre rations away from his base with his morale unaffected by the absence of creature comforts, and
- f. Able to carry exceptionally heavy loads.

9. Despite those impressive credentials, the regular soldier has his weaknesses. He is slow to react to new situations, his skill at arms is only moderate, and he is heavily dependent on the local population for intelligence, shelter, supplies, and labour and is thus vulnerable to any action which interferes with or threatens this support.

10. The regular officer shares many of the characteristics of the soldier. He is poorly educated and subject to considerable political control and his actions are likely to be inflexible and stereotyped.

THE REGIONAL SOLDIER

11. The regional soldier is a term used to describe a man conscripted into a regional body of semi-irregular troops; he only devotes part of his time to military activities and the rest to his civilian occupation. He probably serves mainly in the province of his origin, sections coming from individual villages and companies from a particular district.

12. This soldier probably has no uniform beyond a cap, an arm band, or perhaps a piece of distinguishing clothing or equipment; he may or may not have his own weapon. His training is rudimentary but his local knowledge helps to compensate for this. These troops are likely to be adept in guerilla techniques such as ambushing and sabotage, and a threat to base installations, airfields, and lines of communication.

WEAPONS AND EQUIPMENT

13. The majority of weapons are likely to be of communist origin, though probably not of the latest pattern. Equipment may include all types of artillery, including air defence artillery, rocket launchers and recoilless rifles, machine-guns, and semi-automatic rifles. Tanks and even self-propelled artillery and armoured personnel carriers (APCs) may form part of the armoury in suitable areas. The enemy's main strength is however his foot mobility, and the presence of much heavy equipment tends to negate this advantage. He may have the means to achieve at least local air superiority. His air capability could include reconnaissance, strike, and bomber aircraft and the use of helicopters for coup de main or infiltration operations.

SECTION 3

ENEMY TACTICS

GENERAL

14. The enemy understands the advantages and limitations of the jungle and has developed tactics accordingly. His techniques may, however, differ from those adopted by western soldiers in the same environment and this produces a different type of reaction.

15. The enemy will seek to dominate the jungle by compelling the inhabitants to assist him. These he will treat ruthlessly, exacting food to augment his supplies and punishing informers and those who do not comply with his orders, mercilessly. He will exert his authority over all aspects of the lives of those whose areas he can dominate by a system of terror.

OFFENSIVE OPERATIONS

16. The enemy's likely tactical approach to conventional offensive operations is considered under the advance, preparation for attack, and the assault.

17. The Advance. The advance is likely to be conducted on a wide front by light, mobile columns using all available routes.

18. Preparation for Attack. When the enemy has been halted, his operations are likely to develop on the following lines:

- a. Tactical reconnaissance aimed at discovering the extent of defensive locations. Enemy patrols may deliberately try to draw fire to make the defenders expose their positions.
- b. The provocation of local attacks with the intention of drawing defending troops out of their prepared positions into carefully laid ambushes.
- c. Infiltration for harassing by sniping and raiding.
- d. Infiltration on a larger scale with the object of forming up units to attack the defender from a flank or rear.
- e. Continuous attrition of defended areas by small attacks carried out with determination on outposts of any identified weak points.
- f. Raids on bases and communications.
- g. A build up of vehicles, supplies, and heavier weapons, mainly by night, behind his forward elements to support an impending assault.

19. The Assault. Once the enemy has satisfied himself as to the defender's layout and accumulated the necessary supplies, he is likely to mount piecemeal deliberate attacks with the aim of annihilating individual defensive positions. A likely sequence of operations may be;

- a. A heavy and accurate bombardment by artillery, mortars, and rockets, supported by aircraft where feasible.
- b. The assault mounted by successive waves of infantry from different directions with intense fire support.
- c. A move straight through the area by the main force to attack headquarters and gun areas and cut lines of communication.
- d. The mopping up of the position by following groups.

20. Deliberate attacks of this type are usually well rehearsed. However, if all does not go according to plan, lack of good communications at the lower level and some inflexibility in junior commanders may result in disorganization, particularly if the initial assault is repulsed. It is at this time that the enemy is most vulnerable to counter-attack.

DEFENSIVE OPERATIONS

21. If the enemy is an aggressor, he will not be on the defensive until the later stages of a campaign, by which time his troops, even though depleted and suffering from a lowering of morale, will have acquired experience and become adept at taking maximum advantage of the environment.

22. If the object of the enemy's defence is to prevent the attacker from moving along established routes towards an objective in his rear, the enemy will generally site positions either astride or directly covering these routes, making further progress along them virtually impossible until his positions have been eliminated.

23. If, however, the enemy's intention is to maintain a protected hiding place in which he can remain reasonably secure and yet provide a springboard from which he can mount harassing, guerilla-type operations on the attacker's forces for an indefinite period, his bases are most likely to be located deep in almost inaccessible jungle. His tactics will then be aimed at preventing the attacker from approaching such bases. Features of such tactics might be:

- a. Harassment of the attacker's forces by small, mobile groups armed with rockets, rocket propelled grenades, or automatic weapons.
- b. Frequent, aggressive fighting patrols in the neighbourhood of the base.
- c. The ability to make a clean break from any contact.
- d. The inducement of pursuit with the object of luring the opposition into an ambush.

e. The employment of small stay-behind parties of single machine guns and snipers, possibly protected by mines and booby traps, to force attacking troops to deploy away from selected approach routes and thereby delay their advance.

24. The enemy, when constructing a defensive position, will endeavour to deceive the opposition as to its exact strength and location. Points to consider are:

a. Light reconnaissance patrols will be placed well forward on all likely approach routes to give early warning.

b. Covering troop positions will be some 1 000 to 2 000 m forward of the main position.

c. The main position itself, will be well constructed and concealed.

d. The enemy's resistance to an attack on the main position itself will be fierce and fanatical possibly to the last man. Counter-attacks are likely to be quickly executed but in minor strength as reserves will be held some distance away.

25. A typical position in a remote area may well incorporate some or all of the following characteristics:

a. If sited in deep jungle, it is likely to be situated in accessible and rugged terrain, extremely difficult to pinpoint.

b. It will be completely concealed from the air.

c. Natural obstacles will be used to advantage in the defence.

d. Bunkers from which fire can be brought to bear on an attacker will be tunnelled into the hillside or constructed above ground.

e. Fieldworks will be strong enough to resist bombing and artillery fire.

f. Mines and booby traps will be liberally placed on all approaches and likely forming up positions.

g. Dummy positions may well be constructed in the general area of the base,

h. Depending on the length of occupation and the permanency of the position, extensive tunnel systems with underground vaults and rooms are likely to be constructed to enable the defenders to redeploy, resist attack, or to give them the opportunity to escape.

THE WITHDRAWAL

26. If the enemy is forced to withdraw, he will rely on extensive delaying tactics, moving at night and scattering mines and setting booby traps, sometimes in conjunction with carefully prepared ambushes, along all possible avenues of approach. Rearguard units may well fight fiercely to enable main force units to withdraw. His dependence on the use of established lines of communication, including waterways, during this operation will be governed by the proportion and quantity of vehicles in his order of battle and the number of craft he can obtain. However, the heavier his force, the more he will wish to keep his main withdrawal routes open.

CHAPTER 4

THE EFFECT OF THE JUNGLE ON MILITARY OPERATIONS

SECTION 1

GENERAL EFFECTS ON THE ARMY

GENERAL

1. The conduct of operations in the jungle is influenced both by the climate and the terrain, which impose constraints and limitations on all parts of a force. The jungle is not unfriendly or impenetrable to well trained troops but it does slow down the tempo of operations. Individual actions tend to be isolated by the physical conditions and fighting often takes place at short range in circumstances where a small force can have an influence on the battle out of all proportion to its size.

VISIBILITY

2. Visibility in the jungle is always restricted. In primary jungle, it can be 50 m, in secondary jungle virtually nil. In the wetter seasons, not only does the heavy rain restrict the field of view, but ground mist may also occur and linger for several hours after a storm and in the early morning.

3. Visibility at ground level is of course at its best from high ground but even then only if windows are cut in the jungle canopy. However, even in these circumstances, the view is generally restricted to the roof of the jungle and movement below it is concealed. The restricted visibility also makes natural landmarks difficult to identify and distances hard to estimate. Accurate navigation becomes vital.

4. Air to ground observation is equally difficult as the jungle provides excellent concealment for troops and vehicles, although any activity which has broken or disturbed the canopy will show up. In open areas, observation presents no greater problems than in a European setting.

5. The effect of a restricted field of view on the suddenness with which contacts with the enemy occur in the jungle produces an abnormally high mental strain on the soldier. It requires him to develop a sixth sense, to remain constantly alert and to have reached a high degree of individual training.

MOBILITY

6. The jungle canalizes movement. The dense vegetation, deep eroded gullies, steep-sided hills and ravines, wide, swiftly flowing rivers, and unfordable streams provide natural obstacles which make the soldier's cross-country movement difficult and that of his vehicles and

supporting arms impossible in many areas. During the rainy season, movement across swamp even on foot may be impracticable, and the rate of progress through most secondary jungle and thickets such as bamboo can be painfully slow. Movement is easiest along ridge lines, which generally offer fewer obstacles than the valleys where there are streams and gullies, swamps, and more dense vegetation.

7. Helicopters and fixed wing aircraft can make an important contribution to improved mobility. A small force can be moved swiftly over the jungle to the scene of operations thus making good use of the troops available and retaining considerable flexibility in their deployment. It is, however, difficult to conceal such moves and the security of an operation may be prejudiced. Deception measures can help to solve this problem.

FIREPOWER

8. The jungle reduces the effectiveness of much of the firepower found in modern armies. Because of the problems of observation and target acquisition, long range weapons lose many of their advantages. Short range, manportable rocket and grenade launchers come into their own, especially against armoured vehicles and bunker defences. The difficulty of acquiring targets makes quick, accurate response vital when they appear.

9. Dense vegetation reduces considerably the effect of high explosives. The jungle canopy and the undergrowth absorb the fragments of rounds and reduce the bursting radius of bombs, artillery, and mortar rounds. The reduction of the blast effect is also pronounced. Guided missiles are of doubtful value in thick jungle because of the interference of trees with the wire guidance system.

10. Except on roads and tracks and in large plantations and cultivated areas, fields of fire of all direct fire weapons are considerably reduced and fire lands must often be cleared; these can frequently be best constructed in the form of a tunnel a few metres wide, with the overhanging foliage left intact to retain concealment.

CONCEALMENT AND COVER

11. Jungle vegetation provides excellent cover from both ground and air observation. Strict discipline must, however, always be maintained during movement and the occupation of positions and cutting of foliage reduced to a minimum. Excellent concealment inevitably provides both sides with opportunities for deception and scope for infiltration and ambushes.

12. The density of the vegetation may deceive inexperienced troops into over-estimating the effectiveness of the cover from fire. The small trees may moderate the effect of enemy fire, but they will not provide adequate cover. Although the broken nature of the terrain provides excellent opportunities for (round cover, defensive positions usually need to be properly dug in, using timber to support overhead protection. In some areas, the presence of a high water table can make digging difficult and bunkers may have to be constructed above ground.

PROTECTION

13. The danger of being surprised by the enemy requires constant vigilance whether a force is on the move or halted.

OBSTACLES

14. The jungle is an obstacle to movement and the deep wide rivers, belts of swamp, and thick vegetation can be used to supplement and replace such artificial measures as defensive and barrier minefields.

SECTION 2

INTELLIGENCE

GENERAL

15. One of the major problems confronting every commander in the jungle is the acquisition of reliable intelligence. The jungle can cloak an enemy's intentions as effectively as it conceals his forces, and commanders will constantly be seeking information. The basic principles of intelligence gathering are unchanged but the unusual character of the environment emphasizes certain aspects of operational intelligence and increases the difficulties of collection and dissemination of information. Maps seldom provide adequate information on the terrain or the vegetation and the going cannot often be accurately assessed from them or from air photographs.

SOURCES OF INFORMATION

16. General. The major specialist sources available to a commander are likely to be a combination of some or all of the following:

- a. Area briefs;
- b. Air reconnaissance;
- c. Ground reconnaissance;
- d. Surveillance;
- e. Field Intelligence Officers (FIOs);
- f. Police and indigenous forces;
- g. Local inhabitants; and
- h. Surveillance devices.

17. Area Briefs. These are broad brush summaries of basic intelligence containing detail on topography, climate, communication, population, politics, and economics of the territory concerned.

18. Air Reconnaissance. Air reconnaissance, either photographic or visual, can help in determining the shape of the ground, in identifying settlements harvesting and drying of crops, and in detecting the opening up and use of trails and tracks. The value of this type of reconnaissance will vary according to the character of the country and the degree of concealment it provides.

19. Ground Reconnaissance. Ground reconnaissance is vital in the jungle. It provides the eyes and ears of the commander. All units need to make full use of their reconnaissance elements to locate the enemy at the earliest opportunity during Jungle operations.
20. Field Intelligence Officers. In suitable areas, field intelligence officers may be recruited from organizations such as the local forestry department, otherwise they must be found from the intelligence resources of the force. Their function is to obtain information by keeping in close touch with the civilian population and developing local sources.
21. Police and Indigenous Forces. The local police and indigenous forces may be of assistance and their confidence and cooperation should be obtained at an early stage of operations.
22. Local Inhabitants. The cooperation of the local inhabitants can open up valuable sources of information on the terrain and the enemy not otherwise readily available. The inherited and developed skills of local trackers are an asset which cannot be imitated or acquired. The local inhabitants will, however, always constitute a security risk and the local political situation, tribal, and racial differences must always be borne in mind.
23. Surveillance. A wide variety of technical means of surveillance are now available or coming into service and the various types of unattended ground sensors are of particular use in the jungle where even a large force can quickly be dissipated. Surveillance devices which are able to transmit by radio, and which can be delivered by air or by artillery, will be of great assistance. Well concealed sensors can be extremely difficult to detect and may well revolutionize intelligence gathering in the jungle.

SECTION 3

INFANTRY

GENERAL

24. The infantryman plays a dominant role in jungle operations because of his versatility and relative mobility. All others support him. The soldier introduced to the jungle for the first time must acquire an early familiarity with his new surroundings before he is able to operate effectively. He must overcome a natural fear of the unknown and once he is aware that the jungle is not a hostile environment he must be trained to use it to his own advantage.

PRINCIPLES OF EMPLOYMENT

25. Infantry are unlikely to be used in mass in jungle warfare but will generally be dispersed widely in small units with the prime object of dominating an area, locating the enemy, and destroying him. Continual, silent, and aggressive patrolling is the key to success, and will normally be the major infantry task. In the offence, direct assaults on strongly held positions are generally costly, so the emphasis lies instead on encircling and ambushing the enemy, using the concealment which the jungle provides. The ambush is the most effective means of taking advantage of the concealment offered, and so becomes a major feature of jungle operations.

26. Any form of permanent or temporary base or resting place is vulnerable to enemy surprise attack from close range, and the protection of bases, whether they be platoon, combat team, battle group, or fire support bases, is important.

FIREPOWER

27. Visibility and poor fields of fire place severe limitations on all long range weapons.

- a. Small Arms. Short barrelled weapons like the submachine-gun (SMG) are preferable, however, the 7.62 mm rifle C1 and the automatic rifle C2 are effective at ranges from 0 to 300 m.
- b. Anti-armour Weapons.
 - (1) Personal Anti-tank Weapon (M72). This is an effective weapon which can be fired close to the target from the sides of jungle tracks; it can also be used to reduce bunkers and defensive works. The grenade launcher is also a suitable weapon for jungle warfare being effective against either point targets or small groups of enemy at short ranges.
 - (2) Light Anti-tank Weapon (CARL GUSTAF). This is less suitable because of the heavier weight of both rocket and launcher.
 - (3) Medium Anti-tank Weapon. Not currently available. Same limitations as sub-subpara (2).

- (4) Heavy Anti-tank Weapon. This weapon can normally only be used in areas accessible to vehicles and it is most usefully sited where it can use its range to full effect against enemy armour and transport. The ammunition is heavy and presents a logistic problem.
- c. Mortars. The high trajectory of mortars makes them very suitable for the jungle and they can be used from any small clearing. All commanders should be capable of directing and adjusting mortar fire, as it will frequently be the only indirect fire support able to be brought into range in the early stages of operations.
- d. Grenades. Hand grenades must be used with caution in the jungle as vegetation may limit the throwing distance and be the cause of casualties to friendly troops. Smoke grenades are useful for identifying or locating a force, though the smoke may rise above the canopy at a considerable distance from where it was laid and may thus not be a precise indication of position. The claymore anti-personnel mine can be used effectively, particularly in ambushes.

ADDITIONAL EQUIPMENT

28. Wheeled Vehicles. Vehicles which can be manhandled and require only fairly narrow tracks will be of great assistance, but those which must be confined to the few roads and larger tracks will be of limited use in forward areas. Scout cars will be most useful for road patrols and convoy protection.
29. Armoured Personnel Carriers. The firepower, mobility, and protection afforded by APCs will be useful in areas where the going is suitable. The vehicles are valuable load carriers for rations, water, ammunition, and stores and provide protection against small arms in an ambush, when their radio and fire support will also be an asset. APCs proved themselves useful in the jungles of Vietnam, and provided their limitations and the logistic support needs are taken into account, may be able to play an important part in operations.
30. Explosive Devices. Infantry in a defensive position in jungle will need to make sure of all available devices to avoid being surprised and to illuminate and destroy approaching enemy. The claymore mine, which is easily set up and a very lethal directional weapon, can be used on approach routes and may either be command detonated by the defender or left to be set off by the enemy (anti-lifting devices may be used to prevent tampering). Illumination and trip flares are also of use in these circumstances.
31. Flame Throwers. Flame throwers, if they can be obtained, can assist considerably in the reduction of bunkers and strongpoints and can be used to clear foliage and undergrowth and thereby widen fields of fire in some circumstances.
32. Surveillance and Night Fighting Equipment. The profuse vegetation and steep high hills which limit visibility in the jungle also reduce the effectiveness of observation devices. It is important to select the appropriate device for the task and not overburden the soldier; therefore, relatively light night weapon sights and night observation devices and alarm devices should take precedence over radars.

SECTION 4

ARMOUR

GENERAL

33. The jungle is not the most suitable terrain for armour. While the ground will seldom, if ever, allow the concentration of armour, small numbers of tanks can often be used to support infantry with great advantage. Reconnaissance troops with their better mobility can make an important contribution both in support of infantry and in the performance of tasks such as escorts and patrols.

EFFECT OF THE ENVIRONMENT

34. The jungle has some important effects on the use of armour.

a. Mobility

(1) Movement through jungle is generally inordinately slow and may not be possible at all without considerable engineer support. Except in savannah and on reasonably dry cultivated areas, tanks and armoured reconnaissance vehicles are rarely able to leave the few roads and tracks and operate across country. Dry rice fields are generally passable to armour but swamp and flooded paddy are not normally negotiable.

(2) Armoured mobility in the jungle demands the use of the most up to date information for the careful selection of routes, as heavy rain can swell jungle streams, strong winds can fell trees and tangle vegetation. Areas of forest thought to be impassable may have been recently cleared by local inhabitants or opened up by a forest fire. Detailed ground or air reconnaissance should therefore precede the employment of armour where possible.

(3) The scarcity of routes simplifies the enemy's task in mine warfare and gives him considerable scope for the use of mines and booby traps on and near tracks.

(4) Armoured vehicles are often exposed to attack by low flying aircraft.

b. Firepower. Tanks will not often be able to use the long range of their main armament. HESH and the machine-gun will, however, be very useful in helping to dislodge enemy from prepared positions at shorter ranges. The tank gun may not always be easy to traverse due to surrounding trees and this will increase the vulnerability of the tank. Wire guided missiles cannot operate in close jungle and are only likely to be of value in open areas.

c. Protection. As in all wooded country, the unprotected tank is extremely vulnerable to enemy action in jungle and infantry protection will be constantly required.

d. Factors which may Inhibit the use of Armour in the Jungle are:

- (1) The need for considerable engineer effort to assist mobility.
- (2) The difficulty of mutual support between individual tanks due to restricted visibility.
- (3) The problems of logistic support.
- (4) The scarcity of roads and tracks for wheeled AFVs.

OFFENSIVE OPERATIONS

35. Tanks and armoured reconnaissance vehicles can greatly assist in clearing routes forward provided they are supported by infantry and artillery. However, the possibility of armoured vehicles becoming disabled on narrow tracks and thus blocking the route forward, must be weighed against their value to the operation. The proportion of armour to infantry in the jungle is always likely to be small and it may sometimes not be possible to deploy more than a single tank. The tank gun is an effective weapon for penetrating enemy bunkers and similar positions in deep jungle during an assault and can often help reduce the accuracy and effect of enemy fire on the advancing infantry.

DEFENSIVE OPERATIONS

36. Apart from their normal counter-attack role and augmenting the anti-tank defence, and protection for a withdrawing force as part of a rearguard, tanks can usefully contribute to the following:

- a. Major ambushes, especially alongside a road or track where enemy armour or soft skinned vehicles are expected to pass;
- b. Reinforcing missions moving to the aid of isolated units which are in contact and have to be extricated by fire from fairly open positions;
- c. The defence of jungle bases. Firing from dug-in or hull down positions as part of the defensive plan, tank fire can be particularly effective against infantry assaults. Armour employed in this way will normally also have a counter-attack role.

OTHER ROLES

37. Armour may be employed in convoy and route protection along supply routes threatened by ambush and sabotage, and on the static defence of vulnerable points such as bridges. In a counter insurgency situation, and where the terrain permits, it may also participate in cordon and search operations.

MAINTENANCE AND REPAIR

38. The maintenance and repair of armour in isolated and inaccessible areas of jungle, can present formidable problems. Whether serviceable or not, a tank should never be left unprotected in jungle, and therefore any damage or breakdown will seriously inhibit the movement of a small force. Forward repair is essential in such situations and arrangements must be made for the necessary repair teams and spares to be brought to the tank.

CONCLUSION

39. The jungle provides far from ideal conditions for the operation of armour. However, provided the going is reasonable and engineer support and infantry protection are available, the shock effect and value to morale of tanks and armoured reconnaissance vehicles may often prove decisive. Operational experience in limited war and counter insurgency campaigns has shown that the presence of armour in this apparently unsuitable environment has generally been well worth-while despite the limitations.

SECTION 5

ARTILLERY

GENERAL

40. Artillery has a number of advantages over offensive air support in jungle warfare: it is less restricted by bad weather, is available day and night, and is capable of more accurate and sustained fire, while the support helicopter can confer on it a marked degree of mobility. It will, however, always require close protection.

EFFECT OF THE ENVIRONMENT

41. The main limitations imposed on artillery by the jungle are as follows:
- a. Target acquisition and observation from ground observation points (OPs) is extremely difficult and, although observation from the air will be of assistance, this also is constrained by the dense vegetation and poor visibility.
 - b. Survey is difficult and slow.
 - c. Shells may detonate prematurely in the canopy. However, they will still have some local effect as the blast is contained by the jungle, causing shock and perforated eardrums to troops on the ground. Delay fuses can be used to penetrate the canopy but observation of such fire will be virtually impossible.
 - d. Extreme meteorological conditions, such as tropical thunderstorms, can affect the accuracy of predicted fire.
 - e. The problems of observation may necessitate the use of increased safety distances in the early stages of any engagement close to friendly troops. This problem can be partially overcome by the use of high angle fire which, however, reduces the maximum range.
 - f. Crest clearance problems are a common hazard and proximity fuses may be activated prematurely. Once again, high angle fire can help to overcome this.
 - g. Open areas for gun positions are generally limited but guns can fire from most positions of the size which a helicopter can get into.
 - h. The jungle will increase the problems of low level air defence.

JUNGLE EMPLOYMENT

42. The main roles of artillery in jungle warfare are likely to be:

- a. Preparation Fire. This will normally be concentrated on known enemy strongpoints and bunkers or on parties of enemy located by infantry units within the jungle.
- b. Harassing Fire. Fire can be used to keep the enemy on the move if his general location is known, and it can also be used to force him into ambush positions. Concentrations on jungle tracks may be effective in dispersing enemy convoys.
- c. Covering Fire. This may be directed at likely enemy ambush positions along routes, or against the enemy in the area of a potential landing zone prior to a helicopter assault. It may also be used to help extract infantry from an ambush or similar contact with the enemy.
- d. Defensive Fire. The enemy can often approach to within a short distance of jungle positions without being observed, and defensive fire brought down quickly on jungle tracks and obstacle crossing places can be of vital importance.
- e. Counter Battery. Provided enemy artillery can be located, counter battery fire can be particularly effective in areas where the density of the jungle gives him little opportunity to redeploy.

43. Towed close support artillery which is compact and light, which can easily be slung under a helicopter or carried in an aircraft and which can be manhandled in difficult conditions, is very suitable for the jungle. Guns may be deployed whether singly, in pairs, or as batteries within a defended area or a fire support base (a small, often isolated position between 50 and 100 m in diameter surrounded by a defensive perimeter; such bases will often be located within a brigade or battle group area of responsibility, able to give mutual support by indirect fire to other similar bases).

44. Medium and heavy artillery will always be an asset if conditions are suitable, but it is restricted in scope in the jungle and the problems of deployment and ammunition supply make its use unlikely.

DEPLOYMENT

45. Artillery will frequently have to be deployed into difficult and apparently inaccessible areas to provide support for infantry operations. Some of the methods available are:

- a. Helicopter; guns may have to be dismantled and slung.
- b. Air landing or air dropping on medium stressed platforms.
- c. Manhandling (porters).
- d. Dismantling guns and flying them in, in small aircraft.
- e. Moving by water.

f. Animal transport.

Gun detachments will generally accompany the guns, unless these are moved by air when the crew may have to march to the designated area and receive air delivery.

46. While track mounted artillery has an advantage in negotiating rough terrain, logistic and deployment problems militate against its employment in jungle operations.

47. Considerable effort will often be necessary to cut battery positions out of the jungle, to construct gun emplacements, shelters, and firing positions and sometimes to build wooden pads to prevent guns bogging down on swampy ground.

48. The cover provided by the jungle for enemy offensive operations poses a constant threat to the security of gun areas. Guns should always be deployed in as secure an area as possible such as a fire support base. Because of limitations on the size of a fire support base, dispersion will generally have to be sacrificed to keep the base small, but guns must be well protected against possible enemy counter battery fire or air attack.

TARGET ACQUISITION

49. Target acquisition poses a difficult artillery problem in jungle warfare. The usefulness of sound ranging and radar locating devices is restricted by problems of surveying, lack of suitable tracks along which to move the necessary equipment, and the screening effect of foliage on radar sets, but the equipment will be valuable in that it is probably the only effective means of detecting well concealed enemy guns and mortar sites.

COMMAND AND CONTROL

50. The communications problem may require a degree of decentralization in the command and control system, and batteries may well operate independently of artillery command channels and under the control of the local infantry commander.

ADJUSTMENT OF FIRE

51. Adjustment of fire in the jungle is not an easy task. The OP officer will generally need to be in close physical contact with the infantry commander and thus possibly unable to observe effectively; yet it will seldom be possible for him to move independently to a better OP. The airborne OP is a useful alternative. The infantry must be ready to assist the OP officer by observing the fall of shot and a number of infantry may often have to adjust fire by ear alone.

52. It will frequently be helpful if the first ranging round is white phosphorous, then the smoke will rise through the canopy before mushrooming. When fire is being brought down close to our own troops, this smoke round should be an airburst just above the canopy to preclude it landing on friendly units. Smoke from one gun should be included in the fire for effect as a check that the shells are on the target.

SECTION 6

ENGINEER

GENERAL

53. The limitations imposed by the jungle on mobility place a premium on engineer support. A high proportion of engineer effort will therefore be directed towards increasing this mobility, while at the same time improving natural obstacles to restrict the enemy's means of movement. This section deals with these operations as well as the other tasks which will be required of engineers.

IMPROVING MOBILITY

54. Several factors complicate road construction in the jungle.
- a. Thick vegetation may have to be cleared.
 - b. There will be difficulty in getting equipment and stores to the site.
 - c. The soil may have a low bearing pressure.
 - d. Heavy rainfall poses drainage problems.
 - e. Frequent culverts and large ditches may be needed to cope with flooding after heavy rain.
 - f. The maintenance of existing routes often necessitates almost continual engineer effort.

Furthermore, many parts of the jungle such as swamp and mangrove are completely unsuitable for road building.

55. Engineers may also be required to assist the movement of armour through thick jungle. In this instance, the task is not so much making a route as clearing obstructions such as very large trees which a tank cannot knock down or negotiate alone.

AIRSTRIPS AND LANDING SITES

56. The importance of the helicopter and light aircraft in jungle warfare enhances the need for airstrips, drop zones, and helicopter landing sites. Many of the problems of road building apply also to airfield construction in the jungle.

57. A well surfaced, semi-permanent airstrip may take anything up to six months to construct from scratch in jungle conditions. Temporary airstrips made by expanding or improving existing strips, widening suitable stretches of road or grading grassland and cultivation are therefore preferable to tackling virgin jungle. Cleared areas for the operation of helicopters are likely to present less problems.

58. A more common task is likely to be the construction of helicopter landing sites (See figure 4-2.) Engineer teams with chain saws and explosives can either be roped to the ground from helicopters or landed in an existing small clearing. Such sites may be expanded later into landing zones, if time and available engineer effort permits. When a landing site is constructed on a ridge line, less tree clearance is necessary but the area available may be restricted. (See CFP 320(2) for construction details.)

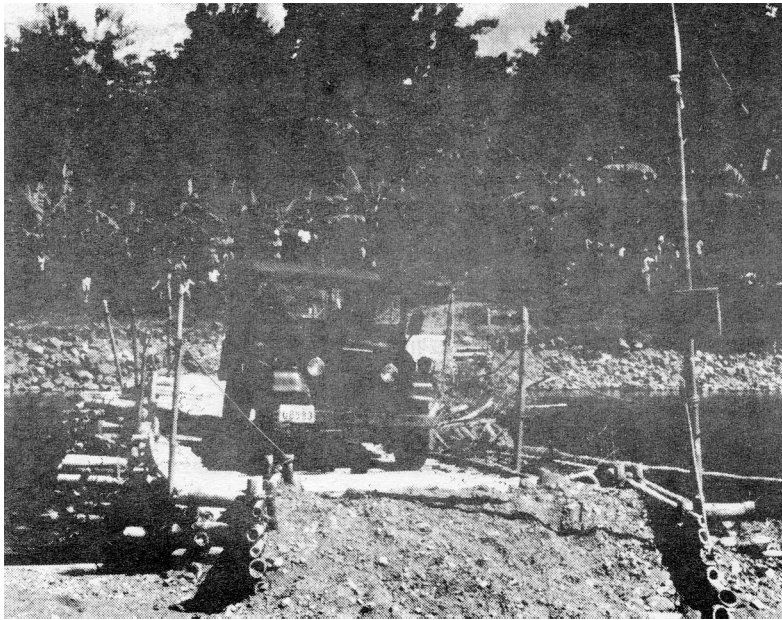

Figure 4-1 Locally Constructed Bridge

OBSTACLE CROSSING

59. The movement of bulky equipment to the site will generally be quite impracticable. However, suitable material for the construction of boats, rafts, and bridges will usually be available locally in the form of timber, vines, and creepers (see figure 4-1). If service bridging equipment is required, this may have to be delivered by air, and complete prefabricated bridges could well be placed on site direct from support helicopters.

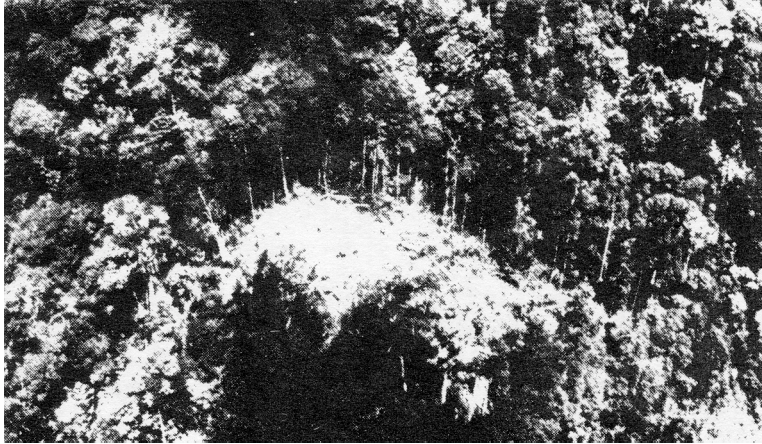

Figure 4-2 A Helicopter LS in Primary Jungle Amongst Trees 60 Metres High

60. The jungle provides excellent concealment for the preparation of river crossing operations but the lack of approaches and exits creates problems for the movement of armour and other vehicles, and the clearing of these may prejudice surprise. Sudden flooding during monsoon conditions is a complication for bridge building and bridges once built will be vulnerable to this threat.

LAND CLEARING

61. In situations where thick jungle provides cover for movement, there may be a need for areas to be cleared to deny their use of the enemy. Main lines of communication might need to be cleared of close vegetation to reduce the risk of ambush and areas close to bases or headquarters may require jungle to be cleared to provide observation and fields of fire and reduce vulnerability to surprise attack. Although defoliation is one solution, it may take weeks to be effective and engineers with dozers, chain saws, and other equipment may have to do the job.

MINE CLEARANCE

62. A jungle enemy will often resort to nuisance mining, especially if he is under pressure or conducting a withdrawal, and a task for engineers accompanying battle groups and combat teams will be to clear the route of mines and booby traps. This requirement is especially necessary when armour is operating in the jungle.

HINDERING THE ENEMY

63. While the natural jungle imposes severe restrictions on the mobility of an enemy force, engineers can compound this problem by intelligent use of mines and explosives. Anti-tank mines can effectively block movement on jungle trails and tracks by stopping one vehicle. Anti-personnel mines and booby traps concealed in the foliage and undergrowth have an important psychological effect on the enemy and will slow his movement in any area where alternative routes are not readily available. The claymore was highly successful both in Borneo and

Vietnam, particularly when used in ambushes or on the approaches to a jungle base or defended area.

64. Mine warfare on a large scale is unlikely to be practised in the jungle for the following reasons:

- a. The jungle is an obstacle in itself.
- b. The reduced tank threat compared to European warfare.
- c. The restricted visibility preventing minefields from being covered by observation and fire.
- d. The difficulty in preventing the enemy from tampering with minefields and obtaining mines for his own use.
- e. The problem of the delivery of large quantities of mines to the combat area, and
- f. The lack of terrain suitable for mechanical minelaying.

The protective and nuisance minefields are therefore the only types of minefield which are likely to be used in the jungle.

65. Route cratering and bridge demolition assume increased importance in jungle where cross-country diversions are infrequent and difficult. Light timber bridges, which occur in many underdeveloped jungle countries, are easy to destroy by burning.

FURTHER TASKS

66. Among other engineer tasks particularly relevant to jungle warfare, the following are worth special mention:

- a. Water Supply. Water is usually abundant in jungle regions but generally needs sterilization and purification. Water sources which are located outside jungle bases will require some degree of protection.
- b. Construction and Destruction of Defensive Works. The setting up of jungle bases and other defensive positions may require engineer assistance or advice; conversely, engineers are often needed to breach defences and demolish or otherwise deny to the enemy captured tunnels, bunkers, and supply dumps. Tunnel systems can be collapsed by surface cratering charges or laying explosives inside.
- c. Assistance to Artillery. Engineers may be needed to clear areas for gun positions and prepare suitable platforms for batteries or single guns in fire support bases or defended localities, especially in swampy and low lying areas.

- d. Dust Suppression. If there is a dry season, dust on jungle tracks and in bases can become a severe problem and may require the addition of special chemicals to the soil in important areas.

OTHER CONSIDERATIONS

67. The following are additional aspects of engineering operations in the jungle:
 - a. Engineer Reconnaissance. Jungle maps are often misleading away from coastlines; the lower reaches of rivers, built-up areas and cultivation and contours are seldom accurate. Arrangements should be made for assembling topographical information on the condition of roads and bridges, sources of construction material, condition of roads and bridges, sources of construction material, conditions of streams and rivers, water courses, potential helicopter landing sites and going for both wheeled and tracked vehicles. Engineers should accompany infantry patrols when the collection of this type of intelligence requires expert knowledge.
 - b. Engineer Resources. The jungle is well provided with timber, which can be used for the construction of shelters, defensive works, rafts, and the laying of corduroy road surfaces and helicopter pads. Some river beds have gravel bottoms but rock formations suitable for quarrying are often inaccessible. Laterite, which is found naturally in the soil in some regions, is an effective building material which compacts well and produces an excellent all-weather base for jungle roads. However, in many areas, the soil is basically clay or loam which does not provide a good foundation for road construction.

EQUIPMENT AND ORGANIZATION

68. Some specialist engineer equipment may be required for jungle operations in addition to normal field squadron scales. Chain saws and other tree cutting equipment are likely to be a priority. However, because of the constraints imposed by inadequate communications, specialist equipment must replace rather than add to normal scales.
69. Because of poor inter-communication there may be a tendency for the engineer effort to be dissipated on a large number of tasks which do not necessarily warrant a high priority in the overall pattern of operations. In this way, too little effort may be left for larger and more important projects, and a considerable degree of centralised control and a clear order of priorities is required. Local labour must be used to maximum to release engineers for priority tasks.

SECTION 7

SIGNALS

GENERAL

70. In jungle operations, forces are liable to be dispersed in small units over wide areas of difficult terrain and rapid and reliable signal communications are therefore vital. Command and control, reporting of information, fire support, resupply, evacuation of casualties, and unit deployment all depend for their effectiveness on reliable radio contact, and all available means should be used to minimize the effect of enemy action and interference. This section looks briefly at the effect of the jungle on the various means of signal communications.

RADIO

71. The jungle affects radio in many ways, the most significant being:
- a. Damp and dense vegetation attenuates a radio signal, often by over 25 per cent.
 - b. Dense vegetation makes it difficult to erect antennae and to get them clear of the canopy. This results in a reduction in communication ranges.
 - c. The high atmospheric noise level and the instability of the ionosphere typical of the tropics aggravates losses from attenuation.
 - d. Large, vehicle-mounted sets have limited mobility due to the scarcity of roads.
 - e. The climate is severe on radio equipment itself, and special care is needed to avoid frequent breakdowns.
72. The specific effect of jungle on the various types of frequency band can be summarised as follows:
- a. Atmospheric conditions are poor in the lower high frequency (HF) band with much noise and interference being experienced, especially at night. Sets, with extended frequency coverage, should provide reasonably reliable communications using ground waves, and a much improved performance using sky waves.
 - b. Very high Frequency (VHF), though free from atmospheric interference, requires near line-of-sight conditions which are very rarely available in jungle areas due either to vegetation or the nature of the ground itself. It is therefore most effectively used for low level command at short ranges.
 - c. Ultra high frequency (UHF) is subject to the same restrictions as VHF. It is an especially reliable form of ground-to-air communication.

73. The difficulty of obtaining direct line-of-sight communications demands efficient, long range, lightweight radios, or the establishment of relay arrangements using high ground and possibly aircraft.

74. Radio Relay. Many of the problems of interference can be overcome by using radio relay which is able to provide a number of speech and telegraph circuits simultaneously. However, line-of-sight communication is essential and the terminal and relay equipment must be properly sited on hills or vantage points clear of vegetation. If such positions are available, helicopters may be useful for positioning the equipment.

75. Relay Stations. Relay stations will often be necessary to ensure communication over extended distances. They can sometimes be positioned by helicopter in places inaccessible to the enemy for the duration of a particular operation.

76. Line. Line cannot easily be laid through dense foliage and its effectiveness is reduced by heavy rain, wet ground, and high humidity. It is also generally very difficult to patrol and thus prevent enemy interference, and it is not easy to recover. Line is therefore unlikely to play a major part in the fluid conditions of jungle operations and its main use is usually confined to base areas.

OTHER METHODS

77. The jungle vegetation naturally reduces visual communications to a minimum. At the lower levels of command, where visual signals are usually employed, coloured smoke or flares which contrast with the colour of the foliage may prove useful. Up to the point of contact, hand signals only should be used in the vicinity of the enemy to avoid loss of surprise; when in contact, sounds which contrast with normal jungle noises, such as whistles, may be necessary.

OPERATING AND MAINTENANCE

78. Radio security in jungle operations is especially important. The dispersion of units into small groups and the advantage of radio over other forms of communication in jungle will increase the amount of traffic and put a premium on efficient operating. The enemy who may penetrate into areas close to our own troops will have increased opportunities for interception of signals or even of eavesdropping on transmissions, unless throat microphones or keys are used.

79. The jungle increases the problems of maintenance; the high temperature and humidity causing rapid deterioration of equipment unless proper precautions are taken. Batteries lose their charge quickly even in storage, and should be kept in the coolest and driest places available. Wire is affected by the weather, wildlife, and fungus, and when outside defended localities, it may be stolen by natives or interfered with by the enemy.

SECTION 8

AIR

GENERAL

80. Jungle operations do not alter the roles of air but its value to land forces is greatly increased. Aircraft are able to operate over wide areas which would take troops on the ground a long time to cover. The reduced force levels which are normal in the jungle mean that small tactical troop lifts and limited logistical support can assume an importance out of all proportion to a corresponding effort in open country.

81. The limitations of air operations in the jungle must be borne in mind. Weather may restrict flying, accurate navigation is generally more difficult, high temperatures affect performance, and payload and dense jungle afford few areas suitable for landing sites or opportunities for emergency landing. Local air superiority is most desirable. However, if not achieved, low flying over short ranges and limited operations by night will still be possible.

AIR RECONNAISSANCE

82. Observation and reconnaissance from the air is valuable in circumstances where movement and visibility are severely restricted on the ground. Air provides a commander with an important intelligence gathering capability in the jungle, although the results of reconnaissance may often be disappointing because of the ease with which a competent enemy can remain concealed. Aircraft can carry out terrain reconnaissance, assess the state of roads, tracks, and streams and identify likely points of ambush and possible drop and landing zones.

83. The cover from view afforded by the vegetation and the extensive cloud or mist which often occurs over the jungle reduce the effectiveness of air reconnaissance. However, the relative speed with which missions can be flown and the reliability of any information obtained make this a potentially valuable source of intelligence.

84. **Visual Observation.** Visual observation is normally carried out at low level and the speed of modern aircraft contributes to the problems of what is, in any event, a difficult art. In the jungle, it should be conducted by pilots or observers thoroughly familiar with the region. Point cover to gather specific information on a limited number of points, or line cover to search designated roads, waterways, etc, will generally be more worthwhile than area cover.

85. Sensors.

a. Photography. Cloud and poor visibility are severe limitations to photography and the good cover of the jungle will make large scale photographs essential. In these circumstances, intelligence on enemy positions can only be obtained by laborious interpretation; the most profitable use of vertical photographs will therefore be as maps in unmapped areas or to supplement or check existing maps. Oblique photographs will generally provide the best chance of revealing activity below the jungle canopy.

- b. Infra Red Line. Infra red line (IRLs) can detect natural infra-red radiation. It is of particular value in the jungle because of its ability to penetrate natural cover, although water vapour in the atmosphere tends to degrade the resolution obtained.
 - c. Radar. Radar has the advantage of being independent of light conditions and of having superior penetration to optical sensors through the jungle canopy and in bad weather. It is therefore a useful supplement to normal photography in the jungle, although it lacks the fine detail of an optical image and stereocopy is not possible.
86. Electronic. Because ground forces in the jungle need to rely heavily on radio, there is considerable scope for electronic countermeasures (ECM) aircraft to intercept enemy transmissions. While this is not strictly speaking a reconnaissance task, it is an important intelligence gathering function providing information on enemy dispositions.

OFFENSIVE AIR SUPPORT

87. Offensive air support in a jungle area of operations may be conveniently divided into:
- a. Interdiction.
 - (1) Both high and low level bombing may be used in jungle to attack enemy units or installations outside the range of ground weapons. Although the density of vegetation absorbs the blast and renders attack less effective than in the open, bombing can have a considerable morale effect on enemy who have previously considered themselves securely hidden. The secondary effects of bombing, such as fires in deciduous forests in the dry season and fallen trees in any area of dense vegetation, can further restrict the mobility of enemy ground forces.
 - (2) Bombing may clear foliage and expose the enemy to further attack from the air. Areas of jungle can be flattened by special bombs, containing material such as liquid propane which exerts unusually strong overpressures.
 - (3) Bombing jungle has the disadvantage that the confusion of felled trees and craters around an enemy position can help the defence and delay attacking troops. Bombing should therefore be used with caution in jungle through which friendly forces may later wish to move.
 - (4) Post-strike reconnaissance is difficult and evaluation of a strike may often only be possible if intelligence sources are available in the target area.
 - b. Close Air Support.
 - (1) Close support aircraft must be able to identify their target and this is a major problem in the jungle, particularly when friendly troops are in contact with the enemy. Smoke can be used for identification purposes but this tends to drift before appearing above the canopy;

air marker balloons have proved an accurate method of pinpointing friendly positions. Alternatively, a flare can be dropped by helicopter to mark a target: if it penetrates the canopy and can be clearly seen.

- (2) Patrol and sub-unit commanders should always be capable of directing aircraft towards a target even though they cannot see it themselves, and they should be fully trained in the request procedures for close air support. Forward Air Controllers (FAC) should, if possible, be airborne so that they can see both the target area and the aircraft they are controlling.
- (3) Examples of situations in which close air support might be employed in the jungle are:
 - (a) Support of ground forces outside the range of ground weapons.
 - (b) Continuous offensive support for a column advancing along a jungle route.
 - (c) Destruction of enemy defensive systems and bunkers by rockets and missiles before ground assault.
 - (d) Provision of suppressive fire in the area of intended landing zones and likely enemy ambush positions.
- (4) Short Take-off and Landing and Vertical/Short Take-off and Landing Aircraft. The jungle favours the use of short take-off and landing (STOL) and Vertical/Short Take-off and Landing (VSTOL) aircraft for close air support tasks. These will normally operate from short prepared strips; in the absence of these, it can use the large helicopter landing zones for vertical take off but this considerably reduces the payload. Subsites are unlikely to be found in battle group areas of responsibility in the jungle because of problems of protection and logistic support.

TRANSPORT SUPPORT

88. Reinforcement and resupply by air will be a usual procedure in jungle operations. If there are suitable landing strips, which may be small and rough, and if aircraft capable of using these are available then it will be economical to land with stores or troops. As an alternative, air dropping or support helicopters can be used.

89. Air Landing. When aircraft can be landed, it will generally be possible to operate a two-way service with returning aircraft carrying casualties, empties, equipment for repair, etc. It will usually be necessary to stockpile fuel and stores at some airstrips, with a consequential requirement for troops to protect them: forward airstrips will also need some protection if they are used at all regularly.

90. Air Dropping.

- a. Air dropping is expensive in equipment, parachutes, and platforms, but may be used where airstrips or landing zones in an operational area are inadequate or nonexistent (see figure 2-17). Loads can be dropped by day into clearings, but if heavy or medium stressed platforms are required, there may be problems over finding suitable drop zones (DZs) in the denser areas. When a suitable DZ has been prepared, it can often be used to receive engineer equipment for the preparation of an airstrip so that airlanding can take place later. Locating a jungle DZ from the air is not usually difficult providing it is marked, though cloud, rain, and haze may hinder operations.
- b. If no suitable clearings are available but an area of jungle can be marked, an alternative method of dropping light stores is to suspend them by a length of line from a parachute: the line should be only just shorter than the height of the trees so that when the parachute is caught in the canopy, the stores fall through and can be recovered easily.
- c. Parachute troops require special training in landing techniques before being dropped into the jungle and some casualties on landing must be allowed for. Drops from high altitudes at night, designed to avoid ground fire and achieve surprise, will need a high standard of individual training. Examples of circumstances where parachute or helicopter borne troops may be profitably employed are:
 - (1) In the early stages of a campaign, when either no bases exist in the theatre of operations or existing ones are out of helicopter range.
 - (2) Where the enemy have overrun bases, and troops need to be inserted to re-establish domination of an area.
 - (3) When a quick reaction force is required to cut-off a withdrawing enemy, reinforce a mission, or exploit an attack in areas where helicopter landings are impracticable.
 - (4) When unusual missions are required involving the use of special forces.

COMMAND AND CONTROL

91. Aircraft can help overcome command and control problems which are greatly increased at all levels in jungle operations. Helicopters may form aerial command posts, giving commanders the advantage of an aerial view, improved communications, and the opportunity to visit their subordinate commanders. Aircraft can also act as radio relay stations and can be used to drop messages.

MISCELLANEOUS TASKS

92. Further tasks which can be undertaken are:
- a. Providing night illumination.

- b. Establishing the position of ground troops. The helicopter homes onto a transmission from troops who are uncertain of their precise position and when overhead, passes them a grid reference.
- c. Dropping ground sensors.
- d. Photography using hand-held cameras.
- e. Spraying defoliant on specific areas of vegetation which need to be denied to the enemy.

VULNERABILITY AND MAINTENANCE

93. Aircraft on the ground can be concealed from enemy air reconnaissance fairly easily by the vegetation, but their location may be given away by the existence of a strip or landing point. Aircraft should not, therefore, be held in forward bases longer than necessary because of their vulnerability to indirect enemy fire or direct assault and in addition because of the extensive backing required to maintain them there.

94. The jungle climate imposes difficulties on aircraft servicing arrangements. Heavy rain and the moist atmosphere present special problems and some form of protection, even if only an improvised tarpaulin cover, is desirable. Except in an emergency, repairs will usually be carried out in rear areas.

SECTION 9

ADMINISTRATION

GENERAL

95. While the principles of good administration apply as much to jungle warfare as to any other operational conditions, the nature of the climate and terrain imposes constraints on the normal means of logistic support and demands modifications to established procedures.

96. The nature of the threat, whereby the enemy may frequently be found astride our communications, adds further to the problem of keeping combat units properly and regularly supplied and dealing with casualties to both men and equipment. The logistic problem is magnified by the increased complication of equipment, and continual efforts are required to keep units on simple, basic operational scales.

97. Non-battle personnel casualties can be a serious restraint on operations if strict health and hygiene measures are not rigidly applied. Soldiers coming from primarily urban communities lack the experience of living under relatively austere conditions, and if they are not trained and indoctrinated properly to jungle conditions, they can be rendered ineffective even before engaging in operations against the enemy.

TRANSPORT

98. Inadequate roads will generally limit the capability for moving large tonnages of cargo over even relatively short distances. Conventional methods of supply, relying on the use of second and third line transport into the forward areas are often impracticable. The various means which may be available are considered in this para:

- a. All weather roads in the jungle are rare and the existing tracks will usually deteriorate rapidly with heavy use. During the wet season, they may be impassable because of mud, landslides, or flooding, and even during the dry season they will often require continual engineer maintenance to remain operational,
- b. The proportion of a force's logistic effort which can initially be moved by road is thus limited and in the early stages of a campaign, there is unlikely to be either the time or engineer effort available to construct new roads or do much to improve existing ones.

99. Railways. Rail facilities in jungle regions are generally limited to main lines between centres of population, which may be only single track, and local lines between plantations or mines and ports or roadheads. Railways and bridges are liable to enemy interference and sabotage, and the main use of rail transport for logistic purposes is likely to be between an entry port and a maintenance area.

100. Air transport can be used to overcome many of the limitations on surface transport, enabling rapid and flexible movement of supplies and equipment and evacuation of casualties

from inaccessible places. Aircraft economically used can often replace surface transport in the jungle logistic chain, though local air superiority must first be obtained and darkness or bad weather can interfere with an operation. The problems of air supply are covered more fully in Sect 8.

- a. The helicopter is especially well suited to the jungle resupply role. It requires relatively little in the way of air-landing facilities; externally carried cargo can be released from the hover and internal cargo can be delivered by a winch cable.
- b. Fixed wing transport aircraft can operate at greater ranges than helicopters, but they require suitable landing strips which are infrequent in the jungle. Some of the problems of airfield construction are covered in Sect 6. Air dropping is an alternative, although a percentage of supplies may well be lost in the jungle canopy or thick undergrowth. Parachutes are expensive and their recovery is difficult. When planning an air drop, consideration should be given to the risks of revealing a unit location to the enemy.

101. Pipeline. The difficulty of laying pipe and ensuring its protection in the jungle is likely to restrict its use to carrying fuel from ships, ports, or beaches to base storage facilities.

102. Pack Animals. The mule, donkey, horse, water buffalo, and elephant can still play a valuable part in transportation in the jungle; they are relatively silent and able to carry heavy loads for long periods. If native handlers are available, they should be used where possible to release troops for other duties, although both animals and handlers will still require a degree of control and protection. Animals leave a trail which is easy to detect and they tend to be temperamental and unreliable under fire. The most common pack animal is the mule which will not normally find grazing in primary or secondary jungle. They usually carry two days' rations for themselves and the driver in addition to their load.

103. Porters. Porterage by either troops or local inhabitants is both slow and laborious but it may have to be adopted in situations where other means are either not available or are inhibited by enemy activity. Clearly, the use of natives is preferable to that of troops; they are more used to the task, should know the area, and can release soldiers for other duties, but their loyalty may be suspect and present a security problem. Where possible, they should therefore be used to cache supplies rather than to accompany or resupply a force. All porter convoys will require infantry protection and must carry their own food and possibly water.

SUPPLY

104. To alleviate transportation difficulties, supplies should be limited to those essential to the task in hand; to reduce the burden on poor surface communications and air delivery, prepositioning of stocks in caches within the operational area should be considered. Request procedures should be simplified and supplies delivered direct to user units avoiding multiple crossloading points.

105. Rations. All perishable food will deteriorate rapidly in the jungle climate. If the situation allows, a frequent supply of small quantities is preferable to larger, less frequent deliveries,

provided sufficient reserves of tinned or dehydrated food are held in jungle bases. The soldier on patrol for long periods will have to rely on some form of lightweight patrol rations and the weight of supplies to be delivered to bases can be reduced by using dehydrated rations, although this will severely restrict the variety of food available. Dry rations held forward should be supplemented by fresh items such as green vegetables, eggs, and bread where possible.

106. Ammunition. The difficulty of observing targets tends to increase the quantity of ammunition fired and there may also be a heavy demand for mines, and for explosives for the construction of landing sites and fieldworks.

- a. The weight and bulk of this ammunition and explosives often presents the most difficult supply problem in jungle areas, though it can be alleviated to some extent by dispensing with the heavy outer packaging in transit.
- b. The jungle climate accentuates problems of storage. Swampy areas are highly unsuitable; firm ground can become a quagmire overnight from heavy rain, and termites eat through wooden boxes. Rain followed by intense heat produces conditions which accelerate deterioration of ammunition and packing material.
- c. The protection and handling of dumped stores absorbs valuable manpower, and if ammunition and explosives can be delivered by air, the proportion kept on the ground in combat areas should normally be limited to the amount needed to sustain operations during periods of restricted air activity.

107. Petroleum, Oils and Lubricants. As only a limited number of vehicles normally operate in the jungle, the call for fuel for these is relatively low; however, wherever helicopters are used, the requirement for aviation fuel will be considerable. Bulk distribution is the most economic means of delivery forward, provided the land routes can take tankers. Ideally, these should pump direct into either vehicles or helicopters but this will seldom be possible and drums or large plastic storage containers may be needed. Alternatively, delivery will probably have to be by drum or jerrican, although these tend to be uneconomic because of the weight of the container, waste during pouring, the risk of contamination due to the humidity and interior condensation, and the problem of backloading empties.

MAINTENANCE, REPAIR, AND RECOVERY

108. The climate and the rough terrain increase the problems of maintaining mechanical equipment. Engines overheat, weapons and equipment corrode, and regular preventive maintenance to reduce the need for repair is essential. It is generally more economical to bring men and spares to a vehicle or large equipment which requires repair, rather than backloading it. Helicopters are useful for carrying technicians to make a rapid diagnosis and for the delivery of spares. Large quantities of spares can seldom be held in combat units in the jungle. Electronic equipment is affected by extreme humidity and it may be necessary to keep it permanently switched on to avoid damage.

MEDICAL

109. Disease Prevention. The provision of medical treatment in jungle warfare is complicated by the climate and the remoteness of operations. Troops operating in the jungle are exposed to a wide range of tropical diseases which include malaria, typhoid, yellow fever, and dysentery. Sickness can be reduced and manpower conserved by sensible precautions and planned preventive medicine and hygiene discipline. The medical services should advise units on these matters and ensure that the necessary drugs are available.

a. Casualty Treatment and Evacuation.

- (1) The principles remain the same as in any other theatre of operations. The need is to evacuate serious casualties to an expert surgical team as soon as possible. The jungle aggravates the problem because units will be scattered in isolated groups and movement of any kind will be extremely difficult. The confidence born of the knowledge that if he becomes a casualty, assistance will be quickly forthcoming, even in the most isolated areas of Jungle, makes an important contribution to a soldier's morale and thus contributes to overall operational efficiency.
- (2) The first requirement will be for proper unit medical cover and a thorough knowledge of first aid by all ranks. This will obviate the need for the evacuation of minor casualties and will enable serious casualties to be well looked after while awaiting evacuation.
- (3) Inevitably, means of evacuation will be scarce and thus it will be more important than ever for medical evacuation priorities to be very carefully assessed.
- (4) Evacuation by helicopter will be the only wholly satisfactory solution and an adequate helicopter force under centralised control will be the most economical method to use. Helicopter evacuation should be supplemented, whenever possible, by other means such as pack animals, vehicles, and boats.
- (5) It may sometimes be possible for a doctor or surgical team to be sent forward with a helicopter evacuation mission, where immediate attention is critical. It will be normal, however, for surgical teams to be centralised in the medical installation to which casualties are flown.
- (6) At worst, some casualties may have to be kept in the forward areas. Although it will not be difficult to conceal them, their protection and their treatment will be a serious drain on the manpower resources of the formation and this could well prejudice tactical operations.

MISCELLANEOUS SERVICES

110. Military Police. Traffic duties will not pose major problems but the handling and guarding of prisoners of war in widely dispersed locations will make big demands on manpower. A close liaison is likely to be required with the local police.

111. Postal and Pay. The importance of mail to troops operating in remote areas of jungle needs no emphasis. Where facilities for spending pay are available, regular payments must be maintained.

112. Pioneer and Labour. Local labour should be employed as much as possible on routine and unskilled tasks consistent with security. This releases troops for a combat role and has the advantage of involving the local population on our side.

LOCAL DEFENCE

113. In jungle warfare, no unit is safe from interference by the enemy and in counter revolutionary operations in particular, the threat from guerilla elements or infiltrating groups of enemy is always present, especially at night; lines of communication are very vulnerable to mining and ambushes.

114. All administrative installations, bases, and headquarters must therefore pay close attention to their own protection with a proper defensive layout and well practised stand to procedures. Administrative movement by road will normally involve the organization of convoys and escorts will be required. These are all a drain on manpower.

CHAPTER 5
JUNGLE SKILLS AND DRILLS

SECTION 1
IN THE JUNGLE

GENERAL

1. The outcome of an action in the jungle is largely decided by the ability of individuals to:
 - a. live and move silently;
 - b. detect and locate the enemy;
 - c. make full use of concealment; and
 - d. shoot quickly and accurately at fleeting targets.
2. Since the enemy can employ similar skills, it is essential to use special techniques to:
 - a. reduce the possibility of being surprised;
 - b. react swiftly and sensibly to sudden contacts; and
 - c. locate and ambush or attack the enemy with complete surprise, to prevent him escaping or counter attacking.

LIVING IN THE JUNGLE

3. The jungle is probably the only part of the world in which the infantryman can operate independently and efficiently for long periods without resupply, due mainly to:
 - a. the warm climate which obviates the necessity for bedding or warm clothing and reduces calorie requirements;
 - b. the availability of water;
 - c. the ability to prevent most of the prevalent diseases by simple measures; and
 - d. the brevity of the short range engagement which precludes the need to carry heavy reserves of ammunition.

4. However, the soldier can only survive providing he is acclimatized, and has a basic knowledge of how to obtain food, water, and shelter, and remain healthy. Physical and mental fitness are a prerequisite to overcoming the climate and resisting disease and if soldiers arrive in the theatre unfit, they are likely to be overcome by the heat and humidity. Instead of becoming acclimatized, they will succumb to a state of languor and mental apathy, which will prevent them taking part in training or operations and make them prone to illness.

5. Soldiers must also overcome any fear of the jungle and adapt to the dank, dark, morbid surroundings. The heat, extreme humidity, and heavy rainfall in many areas demands that they become accustomed to being permanently wet and learn to live with this condition.

6. To endure for long periods, individual loads will be heavy, but they should never exceed 35 kg, divided between:

- a. individual requirements;
- b. patrol requirements; and
- c. special to task weapons and equipment.

7. This load should be distributed so that:

- a. Each man carries all the essentials for survival on his body; if he then becomes separated, he can still live and fight.
- b. To his belt is attached the bulk of his personal ammunition, an emergency ration, water, and a jungle knife.
- c. His pack contains his resupply as well as a few basic comforts.

8. Food and Water.

- a. Jungle foods should only be used in an emergency for survival or to supplement rations since living off the land is almost a full time occupation.
- b. Salt should be carried in all survival packs, as it is difficult to obtain in the jungle.
- c. Lightweight rations will provide rather less energy value than is necessary to meet the energy expenditure of soldiers on patrol. Some loss of weight is therefore likely and men will have to rely on their reserves of body fat. Long patrols which make such demands should, when possible, be followed by periods of recuperative feeding and in a sustained operation the resupply should also take amount of this need.
- d. A cooking pot or mess tin with a tight lid will save fuel and cut down cooking time.

- e. Cold rations should be used whenever there is, any possibility of the enemy being within the range of cooking smells.
- f. Drinking water is usually plentiful in the jungle. It must be filtered through a Millbank bag and then sterilized before use and the amount consumed should never be restricted, except in an emergency.

9. Shelter

- a. A lightweight waterproof sheet of green or camouflaged nylon should be carried and erected to provide a shelter against rain. If soldiers bivouac in pairs, one sheet can be used to sleep on and another as a roof.
- b. In the absence of a shelter sheet, a poncho can be used in the same way with the hood tied up, or a lean-to improvised by laying branches upside down against a ridge pole or tree. Fronds from any of the larger palms are particularly suitable (See figure 5-1.)

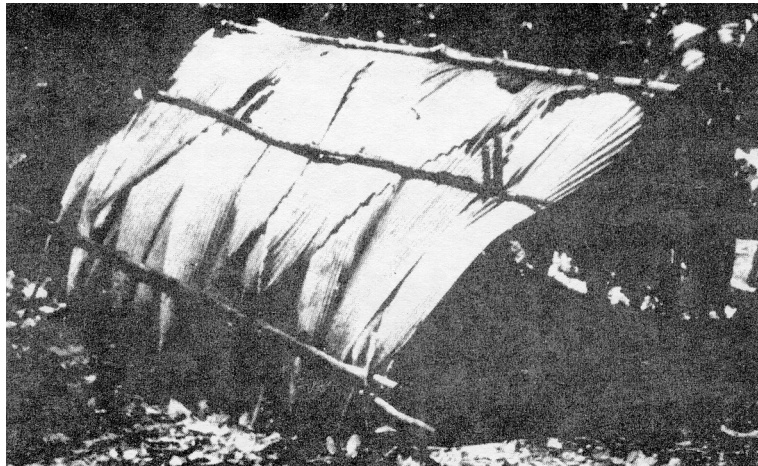

Figure 5-1 A Shelter Made From Elephant Grass

10. Disease Prevention. One man slightly below peak fitness can prejudice or reduce the effectiveness of a whole operation. Some preventive measures such as using mosquito nets and sleeping off the ground are non-tactical and must therefore be applied with commonsense.

The basic essentials are:

- a. Physical fitness;
- b. Strict compliance with medical instructions;
- c. Prompt first aid - to prevent infection;
- d. A balanced diet and plenty of sterilized drinking water; and

e. Cleanliness.



Figure 5-2 A Fallen Tree Can Provide A Useful Path

SECTION 2

NAVIGATION

GENERAL

11. Accurate navigation in the jungle is essential both to find the way and avoid obstacles. Many of the problems disappear with familiarity with an area: this amounts to acquiring a mental picture of the shape of the ground by a few hours of map study aided by visual recognition of areas which have been passed through. Soldiers who have been navigating in an area for many months often fail to acquire a clear mental picture of the ground and rely on recognizing old routes; this is of no help to them when moving over fresh ground.

NAVIGATIONAL LIMITATIONS IN JUNGLE

12. Jungle limits visibility to an extent that almost equates with night navigation conditions and thus requires similar techniques. Except where major natural features are concerned, maps are often inaccurate in regard to minor features such as streams (see figure 5-3) and small hills, and out of date in respect of changes in cultivation, tracks, clearing, etc.



Figure 5-3 Navigation is Made Difficult by Limited Visibility and Streams, Like This One, May Not be Marked on the Map

13. Jungle navigation must therefore be carried out by dead reckoning, that is by plotting the direction and distance covered, confirming with careful checks at main features. Every commander, and at least one other proficient navigator in each independent group, must be responsible for navigating, so that errors can be eliminated by cross checking. Ideally, every man should know where he is at all times.

METHODS OF DIRECTION KEEPING

14. Except in an emergency, no move should ever be made in the jungle without a check on direction. The only practical, accurate guide to direction keeping is a magnetic compass.

15. A Silva type compass with a built in protractor is a very suitable aid, and every man operating in the jungle should ideally have one secured to his body and set on the required

bearing. He should also have a map and know how to use it in conjunction with the compass. A knowledge of the stars will be helpful at night.

16. Routes should be planned to avoid obstacles, and unforeseen obstacles should be bypassed by following right angled bearings to avoid losing direction by feeling a way round an obstruction. (See figure 5-4.)

17. When security allows, navigational assistance can be obtained by visual or radio contact with aircraft or from artillery fire.

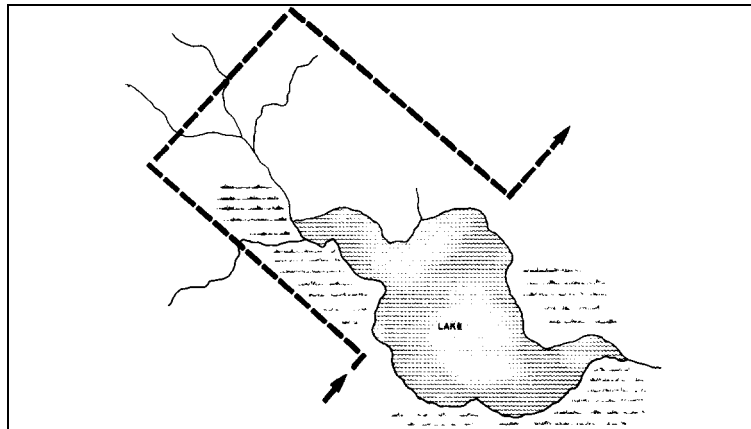

Figure 5-4 Route Taken by a Patrol to Avoid an Obstacle

18. Trackers can be used to back track to the last known position. Local guides rarely have any conception of time and distance and if lost, are often inclined to save face by pressing on and thus worsening the situation.

DISTANCE

19. Counting paces is the most accurate, practical method of checking the distance covered in the jungle, using more than one pacer to reduce errors. Each individual must measure the number of paces he takes to cover a given distance in level primary jungle, and allowance should then be made for the shorter paces taken when moving up or down hill, through close terrain, when tired, or while carrying a heavy load.

20. With experience, estimated rates of progress through different types of terrain can be used as an extra check on the distance covered. As a rough guide, the average distances which fresh troops can cover by day in one hour moving tactically on level ground are (night distance in brackets): clean plantations 4 000 m (2 000), primary jungle 2 000 m (500), secondary jungle 1 000 m (200), swamp 500 m (100).

PLANNING OF MOVEMENT

21. Routes should be planned in straight lines by bearing and distance from main feature to main feature. Bad going should be avoided and main linear features crossed at as near right angles as possible.

22. A view from the air or advantage point can give an indication of the most suitable routes, but unless the area is well known, the going will have to be determined by a careful study of maps, air photographs, and patrol reports. Oblique air photographs are generally more useful than vertical ones.

SECTION 3

TRACKING

GENERAL

23. Sign and tracking are covered in Part Two. However, the techniques of searching are outlined here. See Annexes A and B for details on tracker dogs and tracker teams respectively.

TECHNIQUES

24. Once the track has been lost, a return must be made to the last definite sign and one of the following techniques carried out.

25. Circular Search. This is a quick search and involves a sweep forward in, a semi-circle from the last identified track. If there are two trackers working together in the tracking team, they can each take a semi-circle of a different diameter. (See figure 5-5.)

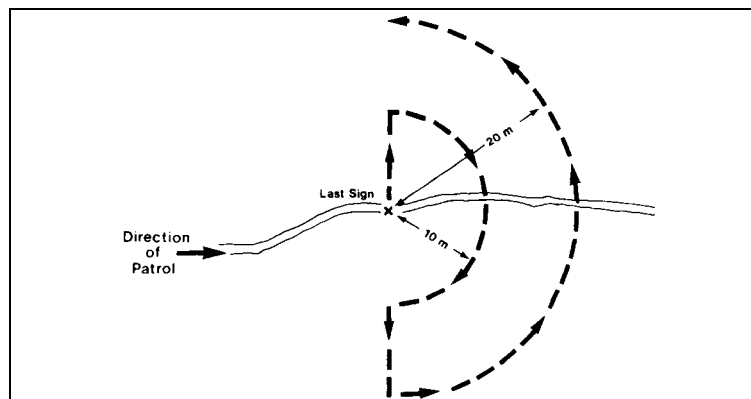

Figure 5-5 Tracking - Circular Search

26. Box Search. This method entails moving forward along the expected track for about 10 m from where the last sign was seen and then moving 10 m at right angles to one side. The ground is then examined on a line parallel to the track and 10 m from it back to a position well behind that where the track was lost. A rectangle is then completed with a similar examination on the further side of the track. If no sign is seen, then a second box is completed 20 m from the track in a similar pattern. (See figure 5-6.)

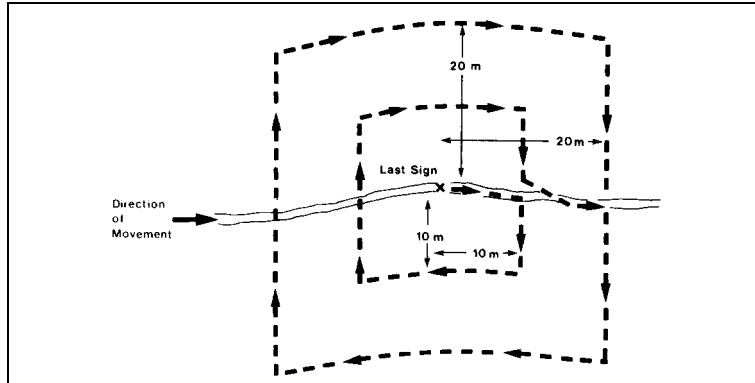

Figure 5-6 Tracking - Box Search

27. Zig-zag Search. A much wider system of search is afforded by this method. It will probably only be used when the circular and box methods have failed. The tracker moves at right angles across the expected track starting behind where the track was lost and searching alternatively to left and right. The distances moved will vary according to the circumstances. (See figure 5-7.)

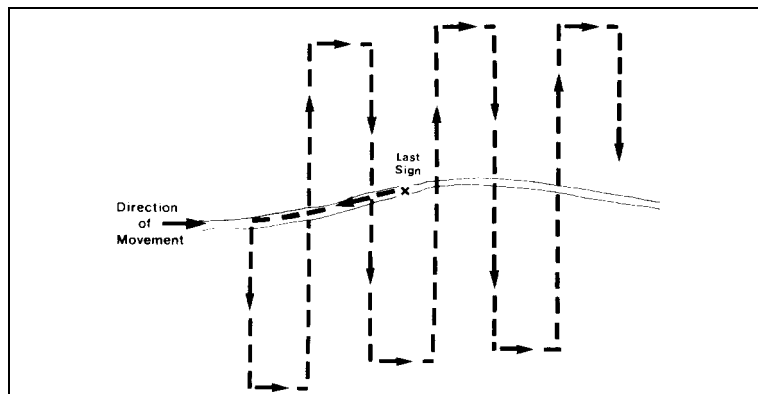

Figure 5-7 Tracking - Zig-zag Search

SECTION 4

JUNGLE MOVEMENT

MOVEMENT ON FOOT

28. Jungle tends to confine movement and channel it into potential ambush killing areas, and it is, therefore, essential that all moves are conducted tactically.
29. Points deserving special attention are as follows:
 - a. In jungle operations, silence must be maintained and signals given by hand until surprise is lost. The skill and alertness of each individual is especially important; a single human error can have far greater repercussions than in more open warfare. It is essential that every man understands exactly what he is expected to do.
 - b. Silent movement is of course very slow and only the commander on the ground can dictate the speed. It is unwise to try and force the pace, as troops who are tired or exhausted will not be fully alert: this is particularly important when returning from an operation.
 - c. In column, control must be from the front to the rear and everyone must continually check that the man behind is following and halt if he is not. If the column splits, the rear portion must remain where it is while the front element retrace their steps to find it. Commanders must be well forward behind the leading group or subunit, and seconds-in-command should be between the rear groups or subunits from where they can exercise command if the forward subunit is ambushed or if action originates from the rear.
 - d. Attached Personnel. Attached commanders and fire controllers should travel with the commander. Their troops should be positioned where they can carry out their task covered by the infantry. They must all be prepared to fight as infantry and must have practised contact, obstacle, and halt drills with the unit to which they are attached.
 - e. Communications. Silent communication can be achieved either by the use of hand signals described in Part Two, or by radio. Once surprise has been lost, control should be exercised by clear voice commands, whistles, smoke signals, or radio. Each subunit or patrol must have long range communications to its base or next higher command.
 - f. Although jungle tends to confine movement to single file, sections should deploy in arrowhead whenever possible to achieve greater all round protection, manoeuvrability, and fire power, Extended line is suitable in the assault and during searches. In any formation, individuals should be up to eight paces apart if visibility permits.

NIGHT MOVEMENT

30. Silent movement at night requires careful planning and the selection of the most suitable route. Exact bearings and distances be followed between check points, which must themselves be unmistakable. If patrol dogs or aids to night vision are used by the leading scouts, it should be possible to detect enemy positions before these are alerted. Providing tracks and defiles are avoided, it is unlikely that a patrol will walk into an ambush at night.

31. An action fought at night in thick jungle is generally confused and seldom profitable. If a patrol is surprised, troops should drop flat on the ground and crawl back the way they have come, freezing whenever the enemy use lights. If they are taking casualties, they should disperse at the run, lie up, and rendezvous (RV) at first light. Shooting back is usually pointless as it will be of more advantage to the enemy. The exact position will seldom be known accurately enough to call down immediate fire support although smoke may be useful. Once clear of the enemy or regrouped at an RV, the patrol commander must appreciate the situation, report to his higher command and take the appropriate action. Troops accustomed to urban living require much practice in operating at night to be effective.

IMMEDIATE ACTION DRILLS

32. Troops moving through close country are likely to encounter the enemy very suddenly at very short range. To ensure that they react immediately and sensibly to an unexpected contact and to give the commander time to carry out a quick battle appreciation, immediate action drills must be laid down to allow for contact with the enemy from any direction. These drills must be:

- a. Simple. So that they can be clearly understood by every man and carried out automatically without any further orders.
- b. Immediate. So that the enemy is caught off balance and the initiative is regained or exploited.
- c. Aggressive. To inflict the maximum casualties.

33. The drills set out in this para must be read in conjunction with the articles on ambushing. These drills provide for most eventualities as follows:

- a. Immediate Ambush Drill Front.
- b. Immediate Ambush Drill Rear.
- c. Counter Ambush Drill.
- d. Contact Drill Front.
- e. Contact Drill Rear.

34. Immediate Ambush Drill Front. This is employed when leading scouts detect an enemy approaching along the same track who is unaware of their presence, and when there is neither the time nor opportunity to manoeuvre. The actions of individual members of the patrol, which are illustrated in figure 5-8, should be on the following lines:

a. Action by Leading Scout.

- (1) Give silent signal for Immediate Ambush Front, indicating which side to ambush.
- (2) Move quickly and silently into cover.
- (3) Complete silence and concealment are more important than a good fire position.

b. Action by Remainder.

- (1) Pass signal back and move diagonally forward into cover on the side indicated and then remain still.
- (2) Take up a fire position, at the same time remaining concealed and maintaining silence.

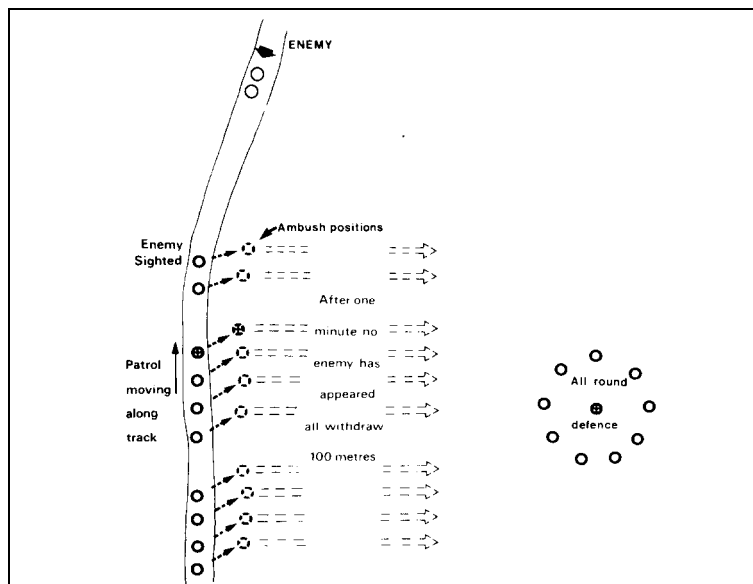

Figure 5-8 Immediate Ambush Drill Front

- (3) The commander must have a clear view of the killing area.

c. Springing.

- (1) When the enemy are in the killing area, the commander will shout Fire.

- (2) On this signal, everyone will fire, adjusting their positions and standing, if necessary, so as to bring the maximum effective aimed fire to bear on the enemy.
- (3) If it is clear that the enemy have seen a member of the ambush before the ambush has been sprung, this man should spring the ambush on his own initiative.
- d. Action if the Ambush is not Immediately Sprung. If the ambush is not sprung within one minute the enemy may have halted, withdrawn turned off the track or perhaps detected the ambush and be taking counter measures. In any event, the ambush must not remain in position after one minute has elapsed: at this time, each man must withdraw silently into the jungle for 100 paces at right angles to the track along which the patrol has been moving. When they have all moved 100 paces, which in thick jungle may take some time, the patrol should take up a position of all round defence. The commander should then determine his next course of offensive action.

35. Immediate Ambush Drill Rear. This drill is used to meet a threat from the rear. A common tactic, which the enemy may well use, is to follow up or track a patrol to attack it at a convenient moment or when halted: this drill should, therefore, be used at any time when it is known or felt that the enemy is following up and at all halts except for short tactical pauses.

- a. Action by Rear Man if He Detects a Following Enemy. Give the Enemy Rear signal discreetly and make sure it is passed forward.
- b. Action by Remainder. Pass the signal forward quickly and quietly.
- c. Action by Commander.
 - (1) When the signal reaches him the commander should proceed as if he was unaware of the enemy until he reaches a suitable ambush position.
 - (2) He should then give the Immediate Ambush Rear signal which must only be passed forward to the leading scouts.
- d. Action by Leading Scout. On receiving the signal, he will take up an ambush position on the side indicated.
- e. Action by Remainder. The second man will go about five paces beyond the leading scout and will take up an ambush position on the same side, each following man will then continue five paces beyond the man in front of him and take up a similar position. The rear group, however, will continue along the track for a further 20 paces, before taking up their ambush positions, to lead the enemy into the ambush.
- f. Springing and Further Action. As for the immediate ambush front, except that if the ambush is not sprung it will remain in position for 10 minutes before withdrawing silently to the halt or harbour position.

36. Counter Ambush Drill. This drill is used if a patrol is fired on or the enemy is detected on a flank.

a. Action by Troops in Contact with the Enemy.

- (1) Shout Ambush Right or Left according to whether the enemy is on the right or left flank.
- (2) Take up a fire position and engage the enemy.

b. Action by Troops out of Contact.

- (1) Shout Ambush Right or Left.
- (2) Close up in all round defence with the 0 Group in the centre.

c. Action by Commander or Senior Rank not in Contact with the Enemy.

- (1) Form up and lead an assault on the flank of the enemy position.
- (2) If it is known that only the centre of the column is in contact, the troops to the rear will carry out the flank attack, while the forward troops remain in all round defence and only fire if they positively identify the enemy.
- (3) During the attack, a clear signal must be given to the troops in contact to cease fire as the assault goes in.

37. Contact Drill Front. This drill is used when the enemy is encountered at close range in circumstances where the immediate ambush drill is inappropriate; the enemy may be bivouacked, crossing the front or themselves in an ambush position awaiting the patrol. In any of these or similar situations, the patrol commander must make a plan and the following drill is designed so as to give him the time and opportunity to do this.

a. Action by Leading Scout.

- (1) Shout Contact Front (unless the enemy is still unaware of the patrol's presence, in which case pass back silent signal for Enemy).
- (2) Take up a fire position, and engage the enemy if Surprise has been lost.

b. Action by Remainder. Repeat the signal and take up fire positions. Engage the enemy if surprise has been lost.

c. Action by Commander. Carry out a quick battle appreciation; if the patrol is part of a larger force he should send back a runner with a description of the enemy position and report on the action he is taking.

d. Further Action.

- (1) Depending on the strength of the enemy position, either the leading section will deal with it, or the leading platoon or company will attack, possibly using the leading section or platoon as a fire group.
- (2) If the enemy position is too strong for the force involved, they should withdraw by fire and manoeuvre, calling for fire support as necessary.
- (3) After an attack, the force should reorganise in all round defence well clear of the enemy position before reporting to their higher formation by radio.

38. Contact Drill Rear. This action is carried out in exactly the same sequence as Contact Drill front but in the reverse order, the rear man shouting Contact Rear or giving the appropriate signal. Like all the above drills, it is completed as soon as the commander has made an appreciation and given orders.

39. Flank Contact Drill. Where the attack comes from the flank actions similar to those performed in para 34 are done. Despite the difficulty of terrain, where there is an unprotected flank(s) a moving body of troops require flank scouts. Most attacks will come from the flanks or rear.

SECTION 5

OBSTACLE CROSSING

GENERAL

40. Obstacles in the jungle cause bunching and troops engaged in crossing them cannot give their full attention to the enemy: in addition, the force will be temporarily split while the crossing is taking place. There is, therefore, a paramount need for vigilance whenever an obstacle is encountered and for close protection of the area during any crossing operation. The enemy will try to exploit this type of situation and may well set up an ambush.

BASIC DRILLS

41. The drill explained in this para is for a platoon-size force: a larger or smaller force would operate in an exactly similar fashion with the appropriate groupings.

- a. On encountering an obstacle, the leading scout passes back the obstacle signal and the commander, covered by the scout group, reconnoitres a crossing and checks the position on the map.
- b. The leading section deploys to cover both the crossing and their rear while the next section negotiates or clears the obstacle and secures the far side.
- c. The rear section continues through the obstacle, becoming the leading section. The first two sections follow.
- d. If the obstacle is too wide to cover in one bound, the process is repeated until the far side is secured.

42. In the case of minor obstacles, there may be no need for the commander to reconnoitre a crossing place and the leading section can then deploy immediately to cover the obstacle while the remainder pass through without stopping.

RIVER CROSSINGS

43. If a major water obstacle such as a river is encountered, it will generally be advisable to form a harbour to cover the crossing, a second harbour subsequently being formed on the far side of the obstacle by the first subunit to cross. Commanders should normally cross with their second subunit, and seconds-in-command with the last subunit.

44. A wide or swiftly flowing river presents both a physical and a psychological barrier. The crossing will be difficult and it will also place a major obstacle between the troops and their base. Good training and physical fitness, swimming instruction, and river crossing practice will generate confidence and thus avoid the necessity of having to use obvious crossing places such as bridges and fords.

45. Jungle rivers can be crossed by wading or swimming, by floats, bridges, boats, or helicopters. The procedure is as follows:

- a. General. When ropes are needed, the strongest swimmers should cross first to secure the far bank, taking the required lines with them. They must also take their weapons but their equipment can be brought across by subsequent groups. In all cases, weapons should be secured to the body with a long nylon cord, and strong swimmers should be detailed as life savers and some positioned down stream.
- b. Wading. Soldiers should face upstream and lean into the current whilst wading across, using a crabwise motion. A strong pole about 2 m long can help to maintain balance.
- c. Swimming. Swimmers should, where possible, swim diagonally downstream to the exit so that they are aided by the current. Flippers are a useful aid to trained swimmers and in deep or fast water, single ropes can assist both swimmers and waders to cross safely. Soldiers should grasp the line downstream facing the current, so that they are in no danger of being swept under the rope.
- d. Floats. Boats, rafts, or improvised means of floatation can be used either to assist swimmers or to float heavy weapons or equipment across. The best method of floating loads across a river is by pulling them across by means of lines from each bank attached to the floats.
- e. Bridges. Trees can be dropped across narrow rivers quickly, but the noise of cutting or explosives may attract enemy attention (hand-operated saws make the least noise). Rope bridges can be set up silently.

SELECTING CROSSING PLACES

46. A few useful points on selecting crossing places are;

- a. Obvious sites such as bridges or fords should be avoided unless secured by friendly troops.
- b. Crossings should be made at low water in tidal rivers, or to and from tributaries or rocky banks, to avoid leaving sign on the main river bank at entry and exit points.
- c. Exit points for swimmers or waders should be selected on the inside of a bend so that the troops possibly exhausted by the crossing are not faced with the deeper, faster water and steep banks which occur on the outside.
- d. Sand or mud banks may make useful resting places, but they will usually show sign unless they are below high water mark in tidal waters.
- e. Strong trees will be needed on both banks to support ropes.

SECTION 6

HALTS

GENERAL

47. Because of the cover afforded an approaching enemy, troops are particularly vulnerable when halted. Halts will be necessary for a variety of reasons and can broadly be divided into:

- a. Pauses of a few minutes only to reconnoitre, check navigation, listen, or perhaps fill water bottles at a stream. They involve intense vigilance but no deployment.
- b. Short halts for up to half an hour for more wide ranging reconnaissance, to make a plan, rest, eat, make radio contact, etc. Providing sentries are posted and everyone remains quiet and alert watching his arc, the immediate ambush drill rear should provide adequate protection for this sort of halt.
- c. Long halts when a longer rest, cooking, washing, preparation of a DZ, or ambush can be accomplished.
- d. Lying up positions which are used as resting places only. No cooking, washing, establishing of radio contact, or other potentially noisy tasks should be undertaken.
- e. Harbour areas which are established to set up a patrol base, assembly area, or for any other longer term function.

48. Except for a pause, all halts should be preceded by the immediate ambush drill rear to foil any enemy attempt to follow up. For long halts, in lying up positions and harbour areas, it is necessary to take steps to:

- a. Reconnoitre a suitable position.
- b. Occupy it in all round defence.
- c. Ensure that no enemy or local inhabitants are in the immediate area, and
- d. Carry out the purpose of the halt.

49. These steps must be completed quickly and silently with the minimum of orders and all units should evolve a standard drill which should be laid down in SOPs and carried out automatically. A method which can be used is explained in this section.

RECONNAISSANCE

50. After reaching the area in which he intends to halt and completing the immediate ambush drill rear, the commander should carry out a reconnaissance accompanied by his runner and an

escort. If a full defensive position, DZ or ambush is to be established, subordinate commanders should form part of this reconnaissance group.

51. When selecting the position account should be taken of those of the following points which are appropriate to the situation:

- a. Concealed and easily defended.
- b. Easily vacated by day or night.
- c. Suitable for radio communications.
- d. Covering a suitable killing area (if an ambush is intended).
- e. Near water (if cooking, washing, or resupply of water is intended) but note that noisy streams will drown the sound of approaching enemy.
- f. Suitable for a DZ or landing point (LP) if required, and
- g. Fairly level and dry for a lying up position or harbour.

52. During the reconnaissance, the unit remains in formation, with each man watching his arc of responsibility. When completed, the runner and half the escort return and bring forward the unit in single file. The commander should remain in the centre of the selected position and visualise the ground as a clock face with the unit entering at 6 o'clock (see figure 5-9).

OCCUPATION

53. The drill for a platoon occupation is as follows:

- a. Sections move quietly to the platoon commander, each man indicating his section number silently by holding up the corresponding number of fingers.
- b. The platoon commander indicates the arc of responsibility and occupation positions. For three sections, the area would be divided, for the first section from 10 to 2 o'clock, the second from 6 to 10 o'clock and the third from 2 to 6 o'clock.
- c. In the case of two sections, the first section would occupy from 12 to 6 o'clock and the second from 6 to 12 o'clock.
- d. In each section's arc, the scout group occupies the centre with the machine-gun (MG) group on its right and rifle group on the left. The scout group and rifle group are about 10 metres and the light machine-gun (LMG) group is about 15 m from the platoon commander.
- e. All MG ammunition is passed.

- f. The section commander adjusts positions and arcs of fire, coordinating with the sections on his right and left, and then places himself in the centre of his scout group.

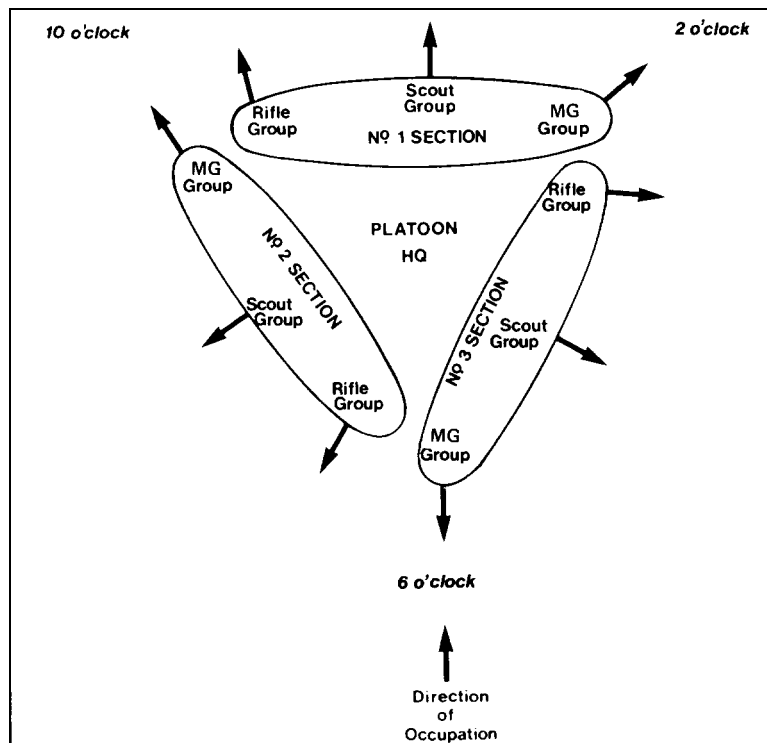

Figure 5-9 Platoon Occupation of a Halt Position

- g. Platoon HQ takes up a position in the centre, out of the way of communication cords from the sections.
- h. The platoon commander checks the perimeter, starting at 2 o'clock and moving anti-clockwise, each section commander meeting him at his LMG group.
- j. Positions, arcs of fire and fixed lines are adjusted, these positions then become the stand-to positions which will be occupied immediately any, firing takes place or the silent stand-to signal is given.

54. This layout provides a triangular formation suitable for defence or ambush and ensures that a gun is covering each apex. It can, with minor adoption, be adjusted to suit any size formation and any shape of the ground.

PROTECTION

55. When the platoon commander gives the signal, clearing patrols move out to search the immediate area of the position. These consist of the section commander and one man from each

group who move out through the left of their rifle group and patrolling clockwise re-enter through their MG position, which must always be manned and warned that patrol is expected.

56. The distance patrols need to clear depends on the maximum range of the noise or smell likely to be created during the work period. If they are likely to be digging a defensive position, cutting LPs or DZ, or any other similar noisy occupation, patrols should move out 300 paces. Where the smell of cooking is the main hazard, this distance can be halved and if no noise or smell is to be made, patrols only move out about 60 paces. Occupation of lying-up position at night does not normally need clearing patrols. As an example of a case when a defensive position is to be dug:

- a. Clearing patrols move out on a bearing from the centre of their positions through left hand rifleman for 300 paces.
- b. Turn right 2 600 mils.
- c. Patrol across 500 paces.
- d. Turn right 2 600 mils, and
- e. Patrol back 300 paces and enter through gun groups.

This ensures that patrols cover the whole perimeter and do not clash. A simple diagram of this operation is in figure 5-10.

57. Before starting his patrol, the section commander should collect all the communication cord from his section. When he has reached the limit of his patrol on the second leg and before returning on the last leg, he should post the first of a pair of sentries. The second sentry is then posted along the last leg at the limit of visibility from the first sentry: these sentries should then be connected by communication cord back to the position. If these sentries, who may be protected by claymore mines, detect any enemy, they should warn the position by a signal on the cord or by firing if forced to. Sentries can also be recalled by the same means.

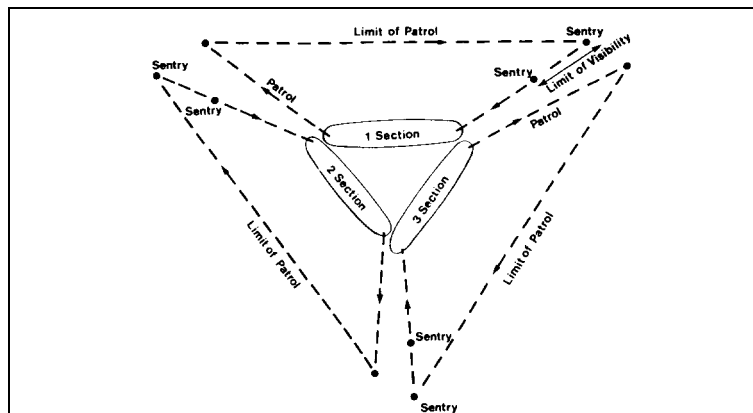

Figure 5-10 Clearing Patrols

58. While patrols are out, the remainder must remain alert in their stand-to positions. On return, patrol commanders report signs of enemy, locals, or tracks found, information on the ground, availability of water, etc. Relieving patrols use same route.

WORK PERIOD

59. The work period should be planned and tasks distributed so that they are completed as quickly as possible; work should be started as soon as clearing patrols have reported back. During the work period, at least one man in each group should stand-to at the MG position.

60. Examples of work tasks which might have to be carried out are:

a. Noisy Tasks

(1) Digging

(a) Defences and obstacles.

(b) Latrines: outside the perimeter covered for day use and within the perimeter for night use.

(c) Refuse pits: these should be 3 feet deep to reduce the chance of their being dug up by animals. It is preferable to remove refuse in plastic bags.

(2) Cutting

(a) Clearing DZs and LPs.

(b) Cutting stakes for protective obstacles, stretcher poles, or supports for weapons firing on fixed lines.

(c) Clearing a perimeter path and erecting perimeter wire if required to prevent troops straying out of the perimeter at night.

(d) Clearing fields of fire.

(3) Speech

(a) Use of radio, such as sending sitreps. The noise can be reduced by the use of larynx microphones.

(b) Orders and briefing.

b. Tasks Producing Smell

(1) Burning

- (a) Clearing DZs and LPs.
- (b) Destroying enemy camps, caches, or supplies.
- (c) Fires: on rare occasions when troops are extremely cold and wet, exhausted or wounded, a small fire can be an acceptable calculated risk to raise morale.

(2) Cooking

- (a) One man should cook for each group, so that sentries and others engaged on work tasks are catered for.
- (b) Dry wood, moss, or grass can be used in a hole fire if wet cloth or towels are hung above to absorb any smoke.
- (c) The smell of food may travel further than the smell of smoke or fuel.
- c. Tasks which necessitate leaving the perimeter. Entry and exit should be made through gun positions which should always be manned.

(1) Resupply and Administration

- (a) Preparation and manning of LSs and DZs and collection of parachutes should be carried out tactically with each working element covered by a fire group. The area should then be left as soon as possible as any air activity is likely to alert the enemy.
- (b) If water or supplies from caches have to be collected, the carrying party should be covered by a fire group.
- (c) Washing at a stream should be similarly protected; with someone being sited to cover both the water point and the washing point downstream of it whenever possible.
- (d) The external latrine should, if possible, be used during the work period.

(2) Defences

Setting up defensive claymores, mines, obstacles, booby traps, and trip flares. These should not be armed until all sentries are in.

(3) Tactical Tasks

- (a) Despatching patrols, ambush, assault, or other groups as required.
- (b) If more than half the force is out, equipment should be concealed and the area made into an ambush by the remainder.

ROUTINE

61. As soon as all the work tasks have been completed, the sentries should be brought into visibility range, changed if necessary, and communication cord adjusted linking them to the platoon commander, section commanders, gun groups, and rifle groups. Smoking or lights must be prohibited, complete silence rigidly enforced and the following carried out:

- a. complete setting up and arming of mines, booby traps, and trip flares.
- b. Make out sentry rosters. Section commanders must ensure that:
 - (1) One sentry is on each MG and one at the extent of visibility from it during daylight.
 - (2) Two sentries are on at night. Relief must be staggered so that at least one of them has full night vision and no sentry be on duty for more than two hours. Each man must know where his relief is sleeping.
 - (3) Sentries are responsible for posting themselves according to the roster, as section commanders and seconds in command may have to take their own turn at sentry duty and must take full opportunity to sleep.
- c. Practise stand-to and make sure every one understands the following signals:
 - (1) Silent signal for stand-to and stand-down.
 - (2) Open fire.
 - (3) Cease fire.
 - (4) Counter attack.
 - (5) Withdrawal by fire and manoeuvre.
 - (6) Silent signal for withdrawal by day or night.
 - (7) Emergency withdrawal to an RV. Short and long term RVs should always be designated.
- d. Clean weapons.
 - (1) One man in each group at any one time.
 - (2) One MG in each platoon at any one time.
- e. Administration.
 - (1) Take medicine.

- (2) Treat medical cases.
 - (3) Redistribute ammunition and stores if necessary.
 - (4) Feed anyone who missed a meal during the work period or at a previous halt.
 - (5) Change socks and clothing, or, if cold, put sweater and jacket on over wet clothing, which will slowly dry out through body heat.
- f. Stand to when necessary wearing full equipment less packs.
 - g. Stand down and post the first pairs of sentries on guns.
 - h. Erect shelters.
 - j. Disarm and collect mines, booby traps, and trip flares.
 - k. Remove all traces of occupation and move, or
 - m. Send clearing patrols and sentries out again if the intention is to remain in the position.

SUMMARY

62. The following rules apply to all halts:
 - a. They must always be tactically sound.
 - b. The drills must be practised until they become automatic.
 - c. The longer a patrol spends working during a halt whether establishing radio contact, washing, or cooking, the more vulnerable it is to detection. It is sensible to spread these tasks over a number of short halts moving on as soon as the purpose of the halt has been accomplished.
 - d. The operational efficiency and duration of patrols can be increased, time saved, and the risk of detection reduced by the use of lightweight rations which require no cooking and reduce resupply problems to a minimum.

SECTION 7

MOVEMENT IN TRANSPORT

GENERAL

63. All movement in transport through the jungle is vulnerable, because it is noisy and because its route, being restricted to the available roads and tracks, is predictable. Security and well practised drills to foil an ambush are therefore, vital. No single vehicle movement should ever be allowed and even non-tactical movement should be carried out in convoy to assist protection.

64. The moves of all convoys must be controlled and the estimated time of their arrival notified to their destination. Prompt action can then be taken if a convoy is overdue and out of contact.

65. Movement on inland waterways presents many similar problems to those on land and suitable precautions should be taken to form and protect convoys of river craft. Movement by air is less hazardous but landing zones are vulnerable to attack and the ambushing of low flying helicopters is also possible. Whilst this section deals primarily with the protection of land convoys, many of the principles and precautions are equally applicable to waterborne and airborne moves and to the protection of trains when these are used.

BRIEFING AND PREPARATION

66. Everyone taking part in a move must be briefed, although objectives, routes, and timings should never be divulged until the last possible moment. The briefing should include all the usual details of the convoy, its composition, order of march, etc, as well as:

- a. Appointment of commanders, alternative commanders and sentries.
- b. State of alertness.
- c. Communications, radio, light, flag, smoke, hand, and other signals.
- d. Action to be taken:
 - (1) If ambushed, fired at, lost or broken down, sunk, or crashed.
 - (2) At obstacles, halts, and dangerous areas.
 - (3) On dismounting, and
 - (4) In emergency.

- e. Any restricting superstructure should be removed from vehicles carrying troops to give the occupants a clear field of fire and observation and the ability to dismount quickly. Drivers and passengers should, however, be protected by armour when possible and in unarmoured or lightly armoured vehicles they should be protected against mines by sandbags on the floor if the extra weight is acceptable.
- f. Mounts for machine-guns should be fitted to unarmed transport, and high angle-iron wire cutters to the front of vehicles: command detonated claymore mines, mounted on steel plates to protect the crew from backblast, can be used on the sides of vehicles against enemy infantry at close quarters. It is useful to have the radio callsigns of vehicles painted on a top surface for easy air identification.
- g. All transport must have adequate tool kits and mine detectors; strong rope or chain should be available for clearing or towing obstacles.
- h. Helicopters should have 60 m of knotted climbing rope secured in the passenger compartment or a 120 m loop of strong rope through a winch or brake (or fitted for rappelling).
- j. As the composition of each convoy or train is likely to differ, obstacle and counter ambush drills must be practised at the beginning of every move and varied if the enemy are likely to anticipate their pattern.
- k. Troops, weapons, and cargo should be distributed evenly throughout convoys or trains. Each complete infantry section or heavy weapon crew should be in its own separate vehicle, wagon, or craft. Stores and packs should be stacked in the centre with troops facing outwards. Heavy weapons, particularly MGs and anti-tank weapons, should be mounted so that they can engage the enemy immediately on contact, and during a move, all troops must be fully alert with their equipment on and weapons at the ready.
- m. Sentries must be detailed for each vehicle or craft to provide all round observation, and a further sentry should travel with the driver or coxswain to guard him and assist or take over in an emergency; in an ambush, this man should remain with the transport to protect it and not take part in any counter attack. Vehicle or craft commanders must travel in the main compartment from where they can command their men, rather than in the cabs of trucks.
- n. Suitable precautions should be taken for waterborne moves and all watercraft must carry paddles, tow ropes, and marker buoys. Stores, packs, and outboard motors should be secured to the craft. Crews and passengers should wear lifejackets under their equipment and each man must have his weapon secured to his body by a long nylon cord.
- p. When trains are used, sentries must watch the sides to prevent enemy operating from the jungle cover boarding or uncoupling coaches.

VEHICLE GROUPING

67. Convoys should move well spaced out in groups of between three and six vehicles to restrict the number that can be trapped in the same ambush. While it may be desirable for individual vehicles to be 200 m, and groups about 800 m apart, the exact spacing and distribution will depend on the availability of escorts and sentries and the security of the route. Convoys should always be split into a point, main guard and rear guard, each of which may consist of a single vehicle, a group, or a number of groups. Engineers required to clear the route should travel with the point, and recovery and medical elements with the rear guard. Armoured reconnaissance troops are ideally equipped to assist with the security and control of road movement and they should be used whenever possible.

ROUTE PROTECTION

68. It will rarely be feasible to picket a whole route, but likely ambush sites, particularly those covering obstacles, bridges, landing points, and positions from which aircraft might be fired on should be secured until the convoy has passed. Such areas may be cleared either by separate bodies of troops or by the head of the convoy dismounting. The order of march of the convoy may thus be continually changing as pickets join the end of the column, and arrangements must be made to retain engineer elements forward and recovery and medical facilities to the rear.

69. Artillery may be able to provide useful support and, when the route is out of range of fire support bases or warships, it may be necessary to leapfrog forward pairs of guns behind the convoy.

70. Helicopters can help by providing observation of the route, fire directing, and relaying radio messages as required.

ROUTE CLEARANCE

71. The route and landing sites should be swept and cleared of mines, booby traps, and other obstacles by engineers, assisted by teams from other arms, who must either be escorted or protected by route pickets.

72. Trains should be preceded by a separate engine moving about 300 m ahead of the main train. This engine pushes a heavy unmanned pilot wagon and pulls a well armoured, armed coach containing engineers and their equipment.

73. Mobile Reserves. A mobile reserve on immediate standby, should be available and positioned so as to reach any part of the route swiftly to assist a convoy; it is sometimes useful if a small follow up force of infantry and a tracker team travels with a convoy to exploit any contact. On occasions, reserves may need to be airborne in helicopters.

74. Counter Ambush Drill

- a. On being ambushed, armoured vehicles, trains, and gun boats should engage the enemy, call on fire transport, and possibly generate smoke, and accelerate to get out of the fire zone. Unarmoured transport should return the fire, generate smoke, and attempt to get out of the killing area as quickly as possible, though vehicles should always avoid verges which may have been mined. If stopped, troops must dismount immediately and engage the enemy from the ground.
- b. Troops outside the killing area should dismount, form up, and attack the enemy from a flank. Clear signals must be given to coordinate the fire of the different parties in these circumstances, and coloured smoke may be useful as a signal to lift fire as the attack goes in.

75. Halts. Moves should always be made without halts if possible. Where it is necessary to halt for less than 10 minutes, troops dismount and take up fire positions in all round defence. For longer halts by day, each group should harbour in a position where their transport can be seen and covered by fire; for longer halts at night, a harbour should be sited round transport which should be concentrated.

76. Maintaining Contact. The commander of each vehicle or craft within a group is responsible for maintaining contact with the one behind; if he loses touch, he must return and make contact. Groups should occasionally slow down to satisfy themselves that the next group is following and re-establish contact immediately if they are not.

77. Recovery. Crashed, sinking, or broken down surface transport should be cleared from the route, guarded, and recovered if recovery elements are following. Otherwise, they should be taken in tow by the nearest vehicle or craft capable of doing so.

CHAPTER 6

JUNGLE TACTICS

SECTION 1

INTRODUCTION

GENERAL

1. In this chapter, various operations are examined against the background of the jungle and tactical concepts are suggested for those circumstances where visibility and mobility are severely restricted. On occasions, even the jungle will be open and well suited to European-type tactics, and in such cases, a force must naturally retain the flexibility to adapt to the prevailing conditions. Some of the considerations which should be taken into account by commanders when planning jungle operations are discussed.

THE ENEMY

2. Commanders will always require the best available intelligence on the strength, location, and intentions of the enemy and this will be difficult to acquire in the jungle. The problems and limitations on intelligence collection are covered in Chap 4, Sect 2.

GROUND

3. The type of country over which operations are to take place needs careful study to establish its characteristics. Intelligence will be required on the availability and condition of routes, density, and type of vegetation, state of the going, etc.

4. The tactical value of ground is less significant than in more open areas where dominating features are generally considered important because of the observation and wide fields of fire which they provide: such considerations are less relevant in the jungle where high ground offers few advantages and the possible lack of water may even make its occupation for a long time disadvantageous.

5. Vital ground in jungle generally centres on means of communication. The jungle has no value for its own sake, although the denial of its free use to the enemy may mean that it has to be fought for and ultimately dominated. Control of the jungle flanking routes, whether they be roads, tracks, river, or railways, is, however, often necessary to allow free access along them and so lay the foundation to successful operations. Bridges, defiles, helicopter landing sites, communication Centres, crossroads, and any lateral routes which assist quick redeployment of forces are other examples of ground which can be important to operations.

6. Dense jungle acts as a serious obstacle to movement, but it is seldom, if ever, impassable and no area can safely be excluded from assessments of the enemy's intentions on these grounds.

TIME AND SPACE

7. Jungle actions are often carried out by small units in separate and loosely connected engagements; in these circumstances, a thorough briefing of all ranks is essential to ensure continuance of the mission should key men become casualties. Time should, therefore, be allowed for a comprehensive briefing especially at the lower levels of command. Close cooperation between the various arms in the jungle can only be achieved if plenty of time is allowed for preparation and liaison.

8. The time required to move units through dense jungle to an objective, forming-up-place or cut-off position must not be underestimated: night movement may at times be so slow as to seem hardly worthwhile. Quick attacks and rapid orders will often be called for on contact, but above company level deliberate orders and adequate preparatory time will generally be the rule.

COMMAND AND CONTROL

9. A characteristic of jungle operations is centralized planning and decentralized execution.

10. Simplicity is the keynote to planning at formation level. While the commander should make his intention and the method of attaining it crystal clear, considerable latitude may have to be left in instructions and orders to allow subordinates to execute them in the light of developments and thereby retain the maximum freedom of action. Poor communications and lack of mobility may preclude detailed changes of plan once an operation has been launched and unduly complicated arrangements for such matters as fire support and resupply may then prejudice success.

11. Radio communication is particularly important for effective command and control in jungle and is almost the only means by which a commander can influence the course of battle. It will often be useful to establish a small tactical headquarters in an area from which radio communication is good; this can then be moved complete by helicopter to another location as and when required. Alternatively, a radio rebroadcast station may be set up on a suitable hill top overlooking the area of operations. Although higher commanders will wish to visit units, this is less easy than in more open country. The helicopter is the only practicable means of rapid transport, but over dense jungle, little can be seen of the situation on the ground and during periods of activity. A commander will generally be more advantageously located at a place where he can obtain the best communications.

12. In dense jungle, where targets are often fleeting and there is little time for positive identification, the danger of clashes between elements of friendly forces is always present and an important planning responsibility is the clear definition of boundaries and tactical areas of responsibility. Accidents, cause unnecessary casualties, prejudice security, and undermine confidence. In order that troops can have the assurance that unexpected activity in their area of responsibility is hostile, boundaries must be carefully defined to match recognizable features such as streams and ridge lines: SOPs or orders must contain precise instructions on such matters

as ground to-air and ground-to-ground identification. The policy on the use of mines and booby traps, another common yet avoidable source of accidents, should also be clearly laid down.

LOGISTICS

13. The general effect of the jungle on the logistic services is covered separately in Chap 4, Sect 9.

14. The scale of supplies considered necessary to accompany a force will vary with the scope and nature of the operation but logistic planning should err on the side of austerity rather than on overstocking in the combat area. The minimum essential rations and ammunition should be held in combat units and the remainder concentrated in reasonably secure areas rather than dispersed in a large number of isolated locations all of which will need guarding. Means should be made available (ideally by air) to distribute supplies rapidly from these secure areas to where they are needed. When resupply is to take place on surface routes, the vulnerability of these must be assessed at the planning stage and resources allocated to secure them. All non-essential administrative traffic should be kept off these routes, thus avoiding the presentation of unnecessary targets to the enemy.

15. The logistic plan will frequently present complex problems and the solution of these will make demands on the ingenuity and resourcefulness of the planning staffs.

SECTION 2

JUNGLE DOMINATION

GENERAL

16. The domination of the jungle is the essential foundation of all successful jungle operations in all the phases of war. Whether the defensive battle has been unsuccessful in preventing the enemy from dominating the area, or whether the enemy has established his authority over a considerable period by infiltration and political subversion, action will be necessary at some stage to return to the jungle and gain control. To dominate jungle, it is necessary to challenge the enemy's ability to control the area, wrest the initiative from him, and finally build LIP an organization that will enable control to be retained: this process is essentially slow and long term.

TACTICAL CONCEPT

17. The success of operations requires the establishment of control over the main routes and potential landing sites, tasks which cannot be effectively achieved until the surrounding jungle has been dominated.

18. A gradual re-establishment of the initiative should be built up in the following outline sequence of events:

- a. Inserting patrols into enemy-controlled jungle.
- b. These patrols set up temporary jungle bases.
- c. Contacting the enemy, harassing, and destroying him from these bases.
- d. Establishing controlled areas around the bases.
- e. Expanding preliminary bases into permanent bases.
- f. Repeating this cycle until separate controlled areas are linked and the enemy is eventually prevented from operating effectively throughout the jungle.

FORWARD OPERATIONAL BASE

19. These are the bases from which jungle operations are controlled and they should ideally be within convenient helicopter turn round of the area of jungle which is to be dominated. They should each contain:

- a. The joint operations room for the area.
- b. A Tac airfield or airstrip, or landing site (LS).

- c. Mobile reserves, including armour where applicable.
- d. Close and long range support weapons.

Such bases must be virtually impregnable to ground and air attack and should be covered by a number of mutually supporting fire support bases. The area around both forward operation bases and fire support bases must be patrolled constantly to deny its free use to the enemy.

CONDUCT OF OPERATIONS

20. Once the Forward operational base (FOB) is established, the sequence of events outlined in this para can be put into effect:

- a. Light, mobile patrols are inserted by land, sea, or air with the task of locating the enemy and the routes he uses and linking up with any known friendly guerilla elements or clandestine military groups.
- b. The next stage is to establish local control over small areas of jungle at a distance from existing enemy base or positions and to find or establish potential landing sites. Movement should be mainly confined to, the daylight hours, activity at night being restricted to ambushes and standing patrols.
- c. These patrols should be gradually reinforced until a subunit of about combat team size can be inserted by helicopter to form a jungle base, perhaps even a fire support base if artillery can be included. The combat team commander is allotted a tactical area of responsibility over which he is required to obtain control by locating, ambushing, and where necessary, attacking the enemy, backed by artillery and any available air support.
- d. At a suitable stage, further combat teams are inserted and bases set up.
- e. Once tactical areas of responsibility have been cleared of enemy and are dominated by friendly forces, they become known as controlled areas.
- f. When two or more combat teams and fire support bases are established, a battle group headquarters may be introduced and a forward operational base formed; combat team controlled areas are then linked to form battle group areas of responsibility.
- g. As the build up continues, further bases are established near the periphery of controlled areas and the process is repeated, steadily expanding command of the jungle.

21. Once those areas through which the main routes pass come under control, the enemy's movement along them becomes a hazardous and expensive business, demanding fresh security measures and thus further weakening his forces. As controlled areas are joined, the enemy's lines of communication will be cut, dividing his forces into isolated areas where they can be destroyed piecemeal.

22. The greater the area over which control is established, the more secure do bases become. Logistic support is built up, helicopters may be moved in, and, provided enough forces are available, the whole operation gains in scope and momentum until complete domination is achieved.

23. Establishment of domination over the jungle includes control of the settlements and where jungle is frequently interspersed with open and built up areas, troops must maintain the flexibility and mobility to switch rapidly back to more conventional tactics. Joint civil police and military cordon and search operations will be needed in places where the enemy have gained the support of the local population, and in these circumstances, the control of areas must be maintained by police action in support of the patrol program. The effect of this should be:

- a. To prevent the population from supporting the enemy with supplies, shelter, recruits, labour, and intelligence;
- b. To maintain law and order and control movement and supplies;
- c. To build up a local defence capability to take over from troops in controlled areas and release them for further tasks.

Where there is no reliable civil or police organization, these functions must remain a military responsibility until local government security elements are established.

FIRE SUPPORT BASES

24. Fire support bases provide fire support in the jungle. They are manned by infantry and artillery and the exact composition, layout, and occupation and withdrawal drills must be carefully worked out to meet different circumstances. The flexibility of operations will often depend on the speed with which these bases can be set up and evacuated. Some of the more important factors to be considered in deciding whether and where to locate them are:

- a. their accessibility;
- b. the air situation;
- c. the strength, firepower, and likely intentions of the enemy; and
- d. engineer resources available.

25. Units or subunits operating from such bases will normally be divided into one element resting and responsible for local defence, and a larger element patrolling in the jungle inside the respective tactical area of responsibility and within range of artillery support from the base.

26. All artillery, mortars, and heavy weapons which are not within forward operational bases should be sited in fire support bases. These should be sited within range of adjacent bases and must be completely dug in with overhead cover and adequate air defence.

27. The infantry element on a fire support base will usually vary between company and battalion strength. The fire support base should include:

- a. At least three strong points dominating the position, overall control being exercised from one of these, each containing a sector command post, the heavy support weapons and reserves of ammunition, water, and rations.
- b. A perimeter of mutually supporting bunkers.
- c. A belt of mines, obstacles, booby traps, and trip flares, including command detonated claymore mines, and a further apron of wire and obstacles at the limit of visibility.
- d. Tunnels or trenches connecting all positions.
- e. A watch tower.
- f. A means of illuminating the perimeter.
- g. Positions capable of all round fire.
- h. Warning devices and listening posts set up in the surrounding area.
- j. A helicopter LS.
- k. Line communication dug in and supplemented by radio and simple visual signals.
- m. Water tanks, latrines, and living accommodation dug in at each position, if it is to be occupied for any length of time.

28. When an airstrip is required, it should be constructed where it can be dominated by fire from the base rather than by expanding and weakening the perimeter to include it.

29. The site of the base should be occupied and cleared in the proper sequence as laid down in Chap 5, paras 50, 51, and 52. After this has been completed, the following additional tasks should be undertaken:

- a. Register support weapon targets.
- b. Lay line.
- c. Construct LS and dig weapon pits.

- d. Clear fields of fire and set up warning devices, mines, trip flares, wire, and obstacles.
- e. Construct strong points and a watch tower.
- f. Construct bunkers.
- g. Link positions with tunnels or trenches and dig in line.
- h. Dig in living accommodation adjacent to action positions.
- j. Improve facilities such as water storage tanks, latrines, kitchens, and showers.

A temporary fire support base may not need to be developed beyond stage d

COMMAND AND CONTROL

30. Communications via a central control are often as fast as, and more secure than, lateral communications during jungle domination operations. The best use of resources and the most effective integration of effort are thus generally achieved when command is exercised at the highest level at which communications can be adequately maintained. In the initial phase, overall control is probably best exercised at long range from a headquarters outside the area, but once forces have become established and intense operations are under way, it may be exercised from a headquarters within the area.

SUMMARY

31. The concept of jungle domination relies on the steady expansion of small forces, initially supported from outside the area, to the strength required to obtain control of a zone of operations. Aggressive patrolling, ambushing, and attacks on vulnerable points, aided by prompt fire support and backed by an expanding series of bases, gradually places the enemy on the defensive, strangles his control of jungle, and puts his communications at risk. The cycle having been developed until a complete region is brought under control, operations may continue in a similar sequence until jungle domination is complete. Jungle domination is, like all jungle operations, expensive in manpower, and the extent to which it can be developed will depend on the size, type, and quality of the forces available.

SECTION 3

OFFENSIVE OPERATIONS

GENERAL

32. When the jungle has been dominated, the way is open for more direct offensive methods. The enemy may be defending approaches requiring rapid clearance for the opening up of routes to important objectives or he may have lost control of the jungle and be ripe for final expulsion; alternatively, an approach march through jungle relatively free of enemy may encounter opposition requiring a quick assault or envelopment. In such situations, a fairly traditional concept of offence can be applied, though considerable modifications to tactics are still necessary.

33. This section considers tactical doctrine for offensive operations at battle group level and in general terms. It is assumed that such operations will be mounted in a situation of at least air parity, and preferably superiority, over the theatre or operations. Sect 4 deals with the attack in detail.

EFFECTS OF THE ENVIRONMENT

34. Some important effects of jungle conditions on offensive action are as follows:
- a. The excellent concealment provides opportunities to achieve surprise. It increases the traditional advantage of the possession of the initiative by the attacker and favours the use of fighting patrols and infiltration.
 - b. Individual offensive actions tend to be dispersed and fragmented.
 - c. Actions frequently arise out of unexpected encounters and depend for success on an unusually quick response.
 - d. The scarcity of suitable support weapon positions and limitations on observation cause difficulties in the provision of both direct and indirect fire and emphasise the need to have several alternative means available.

35. An offensive force in the jungle needs information and adequate strength and mobility to accomplish its task. The composition of the force will generally include a preponderance of dismounted, lightly equipped infantry, possibly with armoured support in suitable terrain. Artillery is required to provide indirect fire, while helicopter borne and possibly parachute troops can be effective in small numbers in the enemy's rear areas when adequate landing and drop zones are available. The force should be well balanced at combat team level and able to accomplish the task with the minimum of additional support, and mobile reserves should be available for quick deployment ideally by helicopter at both battle group and formation level.

APPROACH MARCH

36. Large scale movement through jungle presents unusual problems and requires careful planning. The following may influence the tactics adopted:

- a. The configuration of the ground, the type of vegetation, and any marked changes anticipated along the axis of advance.
- b. Likely enemy ambush sites.
- c. Known or suspected locations of covering force elements which can provide the enemy with early warning.
- d. Cleared areas adjacent to the axis of movement which may be suitable for use as gun areas or landing sites for an advancing force.

37. A compromise is invariably necessary between speed of movement and vulnerability to ambush. If the enemy is known to be located in strength on the main approaches, it will be necessary to decide whether to bypass these by moving through more difficult going, which will in itself be time consuming, or deliberately to sacrifice speed by careful probing down the main route, locating enemy positions, and finally forcing him out of these so as to open up the way forward.

38. The principles of the approach march can be summarized as follows:

- a. Movement through jungle should be carried out on as wide a front as is practicable. A force can often be split into a number of separate columns moving along narrow tracks, ridges, dry water courses, etc, on a one-man or one-vehicle front.
- b. Damaged routes and landing sites secured by the force should be made usable as quickly as possible, and engineers kept well forward accordingly.
- c. On contact the strength and nature of the opposition must be established as soon as possible.
- d. Although immediate frontal assaults may succeed against a weak or dispirited enemy, determined opposition will generally need to be bypassed and enveloped.
- e. A reserve must be available to reinforce successful action, cut off withdrawing enemy-, or meet enemy counter-measures directed against lines of communication. Helicopters should be specially earmarked for such missions.
- f. Vehicle columns supporting the advance should have escorts that can deploy rapidly off the road to counter ambushes: tanks and armoured cars may be useful in providing covering fire.

- g. Once a route has been cleared, it will remain vulnerable to infiltrating enemy and their lay back patrols, and must be kept open (if enough troops are available for this) or re-cleared when necessary.

39. The speed of advance will depend on the type of jungle, availability of routes, and strength of the opposition. The approach march is a slow and frustrating phase of operation against an enemy experienced in guerilla and delay techniques, and it must be undertaken with patience.

ATTACK

40. Attacks in jungle may either be quick or deliberate, depending on the circumstances and the strength of the opposition. They will usually involve some form of envelopment, which may sometimes be executed in conjunction with a frontal assault. The main points of planning and execution are as follows:

- a. Objectives must be unmistakable and well within the capacity of the attacking force. Limited rather than deep objectives should be planned, and assault distances kept short.
- b. Accurate direction keeping is essential. The axis of assault should follow an identifiable natural feature where possible.
- c. Attack frontages must be narrow to ensure efficient concentration of firepower.
- d. Direct fire from tanks or aircraft should be used against enemy strong points.
- e. Once cleared of enemy, each objective should immediately be organized against counter attack.
- f. Night attacks are less advantageous in jungle than in open country. The foliage allows a close, concealed approach by day, and hinders control at night.

EXPLOITATION

41. The aim of exploitation after an ambush, attack, or contact is to complete the defeat of the enemy who must be relentlessly searched out, pursued, and destroyed.

42. Once the enemy begins to withdraw, he should be pursued and destroyed, before he can disappear into the jungle. The following will help in this phase:

- a. The use of surveillance devices and patrols to identify withdrawal routes; these will have to be prepositioned.
- b. The use of helicopter borne reserves to cut the enemy's escape routes.

- c. The harassment of withdrawal routes by close air support, armed helicopters, and artillery.
- d. The use of fighting patrols to disrupt lines of communication and ambush likely withdrawal routes.

43. Exploitation can be a difficult operation because of the problems of maintaining control and the danger of ambush while pressing the pursuit. Commanders must be prepared to take risks if the initiative is to be retained. Good communications will improve control and minimize the dangers.

44. A commander should indicate the action to follow a successful attack in his initial orders; this is likely to include:

- a. Consolidation.
- b. Follow up.
- c. Search, collection, and evacuation of casualties, prisoners, and material.
- d. Ambush of enemy reinforcement.
- e. Resupply and reinforcement of own troops.

45. Consolidation. After an attack or ambush, a harbour should be occupied on a previously selected and easily defended feature well clear of the objective. Close cordon and ambush groups should be called in but more distant ambush positions may remain in position as long as there is a chance of ambushing escaping or reinforcing enemy.

46. Follow-up. When the situation is opportune, escaped enemy should be followed up immediately. In these circumstances, a combat tracker team, the composition of which is described in Annex B, may be a useful aid to the follow-up force. These teams should always be available to follow-up a contact and should be brought in by the quickest possible means. Helicopters can also assist in locating an escaping enemy. The follow-up force must be prepared to deal swiftly with the enemy whenever further contact is made or where he is employing delaying tactics or ambushes.

47. Search. Search groups may follow the assault or carry out their task as a separate phase. In either case, they should be covered by fire groups who should help direct the search.

48. The area to be searched should include the whole area of the enemy position which may include tunnel exits and hides. It should be divided into sectors which must be searched slowly and systematically by groups assigned to each sector, with further groups held in reserve under the overall control of a search commander. Searches must be well trained in locating tunnels, hides, and booby traps and know how to neutralize them; breaching teams are particularly

suitable for this task. Areas which have been searched must be kept under observation until the search has been completed to prevent enemy returning to them.

49. Ambush of Enemy Reinforcements. Immediate ambushes, reconnoitred before the main attack, can be set up on likely enemy reinforcement and follow up routes.

50. Resupply and Reinforcement. Resupply and reinforcement should take place as soon as possible: resupply points must be protected as for a harbour, as discussed in Chap 5, Sect 6. Standard resupply packs should be laid down in standard operating procedures (SOPs) so that they can be called for by a simple code.

TACTICAL INFILTRATION

51. Tactical infiltration is the means by which troops are moved under cover of the jungle to positions in the enemy's rear with a view to either attacking him from an unexpected direction or forcing him to withdraw. Infiltration may be used either as the principal feature of an operation or as a supporting or diversionary one for an attack elsewhere. Typical tasks could be:

- a. Isolating or enveloping the enemy's positions and restricting the movement of his reserves.
- b. Securing features such as crossroads, bridges, or defiles or laying ambushes on lines of communication, and
- c. Harassing or destroying headquarters, gun areas, supply bases, and maintenance areas.

52. A typical infiltration force might consist of infantry with a forward observation officer (FOO) party and an engineer team attached. The force must be flexible enough to react to the unexpected and orders should specify alternative tasks. Planning should cover a subsequent link up with the main body and measures for extracting the infiltration force if the need arises.

53. Infiltration takes full advantage of jungle conditions and can make an important contribution to the overall success of operations. Even if discovered, a well dispersed infiltrating force is not easy to neutralize or destroy and a large number of enemy will be required to surround it or prevent its safe withdrawal.

54. While surface methods are probably the most secure, troops can also be infiltrated by helicopter with the attendant advantages of speed and flexibility but at the risk of losing surprise.

DEEP PENETRATION

55. Deep penetration is the insertion of relatively smaller forces deep into the enemy's rear areas. It should be carried out by well trained teams operating independently against strategic targets such as higher headquarters, airfields, and support installations on the lines of communication.

SUMMARY

56. Successful offensive action in jungle depends on accurate intelligence, simplicity in planning, good control, and adequate fire support. The jungle gives scope to the attacker for using concealment, exercising deception, and employing mobility to the full to outwit and destroy the opposition. General principles of such action can be summarized as follows:

- a. Every means of reconnaissance and surveillance should be used to locate the enemy.
- b. The routes and potential landing sites in the path of an advance must be secured or denied to the enemy.
- c. Once contact has been made, it should be maintained while the precise strength and disposition of the enemy is established.
- d. Offensive action should then be mounted as rapidly as possible before the enemy disperses or can be reinforced.
- e. Direct frontal assault of strongly held defences should be avoided whenever possible and advantage taken Of jungle cover to envelop or bypass the enemy and attack him from an unexpected direction.
- f. Close coordination is essential between mobile elements and artillery and air support.
- g. Reserves must be readily available to exploit success.

SECTION 4

THE ATTACK

INTRODUCTION

57. Jungle terrain can include open grassland, arable land, and villages where conditions are not unlike those found in Europe. In such areas, an attack is carried out in a conventional fashion and should pose no special problems to properly acclimatised troops. However, most jungle country consists of primary and secondary jungle, swamp, and extensive dense plantations which place severe limitations on visibility and mobility. It is under these conditions, that jungle tactics differ in detail but not in principle from those which would be used in Europe. This section therefore deals with some of the problems which arise when mounting an attack in dense jungle and suggests methods of overcoming them.

58. The Quick Attack. Unexpected encounters with the enemy are not unusual in dense jungle and because they normally take place at very close range, they require instant reaction to gain the initiative. In these circumstances, it will not, as a rule, be possible to go through the normal sequence of reconnaissance, planning, and orders and so immediate action drills have been devised. The quick attack was covered in Chap 5. This section deals only with the deliberate attack.

59. Types of Enemy Position. There are two main types of enemy position with which we are concerned. These are:

- a. Strong and well prepared defensive positions which may consist of:
 - (1) Mutually supporting bunkers and strong points.
 - (2) Connecting and escape tunnels or trenches.
 - (3) Wire, ditches, caltrops, palisades, zarebas, and water obstacles.
 - (4) Booby traps, claymores, mines, and trip flares, and
 - (5) A warning system of informers, patrols, ambushes, and dogs with a screen of delaying devices and booby traps on the approaches, and
- b. Temporary positions, camps, and harbour areas which will be less well prepared and more easily breached.

THE CONCEPT OF THE ATTACK

60. A detailed reconnaissance of the enemy position is essential to discover its extent and weak points if these exist. The subsequent planning should aim to exploit any weaknesses found

and should take every opportunity to achieve surprise by attacking the enemy from an unexpected direction.

61. The scope of the attack in dense jungle is inevitably limited by the restricted visibility and the consequent difficulty of maintaining control of both the assault and the fire support. Distances must therefore be kept as short as possible, start lines must be as close to objectives as is feasible and objectives themselves must be clear and limited.

62. It will often be preferable to break down an attack into a series of phases with limited objectives: each objective being the target for a separate assault group with fire support provided by another clearly defined group.

PLANNING

63. The appreciation and outline plan should produce:

- a. The number of objectives and assault phases required.
- b. Axis of assault.
- c. Fire group position.
- d. Diversionary operations.
- e. Type and position of cordon.
- f. Assembly areas and Forming up places (FUPs).
- g. Grouping.
- h. Fire plan.
- j. Exploitation, and
- k. H hour.

GROUPING FOR THE ATTACK

64. It will generally be necessary to divide the attacking force into the following components:

- a. Cordon troops.
- b. Assault force.
- c. Fire support.

d. Reserves.

65. Cordon Troops. A cordon is used to isolate an enemy position, to prevent reinforcement and to intercept any enemy attempting to escape. However, a close cordon backed by mobile reserves is rarely possible or effective in dense jungle. The most successful formation is likely to be a number of small groups disposed around the enemy position on all the likely routes in a series of ambushes. There must, however, be sited with great care and arcs of fire must be coordinated to ensure the safety of the assault and follow up troops. Ambushes should be sited fairly close to the objectives in a situation where the enemy are likely to try and break out in groups; if the enemy is likely to disperse individually, ambushes should be sited at a greater distance from his position so as to catch these individuals after they have regrouped.

66. The Assault Force. The following elements may be required in the assault force:

a. Assault Groups. These are required to carry out the assault. Enough groups are needed to enable a fresh one to be inserted at each phase of the assault, so that they can pass through each other and hold the ground won until the position has been fought right through and all resistance has been eliminated.

b. Fire Groups. These are needed to provide close support, usually with machine-guns and light anti-tank weapons medium anti-tank weapons (LAW/MAW), to each assault phase in turn: there may therefore need to be several fire groups for one attack.

c. Breaching Groups. When defences have to be breached; infantry or engineer breaching parties will be required to clear an opening for the assault. They may also have to clear an approach to fire positions to enable the fire group to engage the enemy and to clear further obstacles, tunnels, and bunkers within the enemy position during the assault and mopping up phases.

67. Fire Support. Fire support by artillery and mortars will normally be provided from a fire support base. Armed helicopters may operate from forward operational bases or fire support bases.

68. Reserves. Mobile reserves should include tracker teams and armour where terrain is suitable, and have a helicopter lift available. Their main tasks are likely to be to:

a. Break up counter attacks.

b. Reinforce the cordon troops and prevent enemy reinforcement or escape.

c. Exploit success, and

d. Cover a withdrawal.

TIMING OF THE ATTACK

69. An early morning attack is usually preferable, as it allows more daylight for consolidation and exploitation, although advantage can sometimes be taken of bright moonlight. The best time to attack will depend on the enemy routine, but it is likely to be either:

- a. Before the enemy stand to at dawn.
- b. After dawn when they have stood down, and
- c. Mid afternoon in the heat of the day when they may be resting.

As night movement is slow, tiring, noisy, and difficult to control, a dawn or night attack will usually entail deployment before last light.

70. All timings should be worked backwards from H-hour, the selection of which will depend on:

- a. How long the infantry and supporting arms will take to deploy.
- b. The time required for the assault and mopping up, and
- c. How much daylight is required for exploitation.

71. It may not be possible to fix a firm H-hour if the approach is difficult and H-hour may often have to be expressed as no attack before a certain time, to allow all elements of the force to get into position before the order to attack is given.

METHOD OF THE ATTACK

72. Deployment. The main assembly area should be on the axis of assault. However, ambushes which are sited some distance from the objective will probably require separate assembly areas. Assault and fire groups must not move from their assembly area until the cordon troops are in position. They should then deploy into assault and covering fire formations at FUPs behind their start lines. In a silent attack, the assault troops must crawl up to their start lines with the utmost stealth which may take a comparatively long time.

73. Fire Support

- a. Artillery and mortars should be deployed into fire support bases prior to the assault.
- b. Aircraft should not be introduced into the target area until assault troops are in position, unless surprise has already been lost. Airmarker balloons are useful to indicate the position of our own troops relative to the enemy.

- c. Fire controllers must be in a position from which they can keep supporting fire a safe distance ahead of the assault. This may necessitate the fire group moving their positions closer to the enemy.
- d. Because it is often difficult in the jungle to see when fire on the enemy positions has lifted prior to the assault, the final salvo on the objective should, if possible, include some smoke which will be a clear indication to the assault troops and enable them to follow up closely with confidence.

74. Breaching

- a. The three most usual methods of breaching enemy defences are:
 - (1) Silent beaching, which can only reach as far as the enemy's forward troops.
 - (2) Quick breaching, breaching parties will precede the assault and fire groups through the outer defences, then follow through behind the leading assault wave to clear further obstacles and assist in mopping up.
 - (3) By supporting fire. This will generally mean that start lines will need to be further back to avoid casualties to own troops.
- b. Each breaching force should have its own covering party and the necessary equipment to clear any obstacles encountered. Such equipment may include:
 - (1) Bangalore torpedo, baby viper, pole, and shaped charges.
 - (2) Flame throwers (if available).
 - (3) Mine and chemical detectors and specialist dogs.
 - (4) Probes, lifting devices, low ropes, saws, axes, wirecutters, pliers, tape, safety pins, and troches, and
 - (5) Demolition equipment and initiating devices.
- c. Infantry weapons and goats, pigs, dogs, and other animals can also be used to clear mines and booby traps. Ladders and rope may be needed to scale obstacles. Other material may be required to clear tunnels and bunkers.

75. The Assault

- a. Start lines for fire and assault groups should be as near right angles to each other and as close to the objective as is possible without the attacking troops becoming casualties from supporting fire.

- b. At H-hour, or a clear signal to attack, the fire group should dash forward to their fire positions and engage the enemy with heavy, aimed fire. At the same moment, the first assault group must attack its objective.

MOPPING UP

- 76. Once the main assault has succeeded, fire and breaching groups should assist assault groups to mop up and clear their objectives. Assault groups must hold their objectives until the whole position is cleared to prevent enemy slipping back into cleared areas or escaping by way of tunnels.

SECTION 5

DEFENSIVE OPERATIONS

GENERAL

77. This section examines the conduct of defensive operations. The jungle favours an attacking force. The main limitations it places on the defender are as follows:

- a. The dense terrain absorbs manpower.
- b. The limited visibility allows the enemy to approach close to positions without being detected, encourages the use of infiltration, and increases the likelihood of being attacked from any direction.
- c. Short fields of fire limit the effectiveness of all but short range, direct fire weapons.
- d. The lack of visual communication between separate elements of the defense rules out the use of mutually supporting direct fire between defended localities.
- e. High ground does not normally provide good observation or fields of fire. Where it does, it may be especially obvious and thereby vulnerable to enemy attack.
- f. Surface lines of communication are vulnerable to enemy interference.

78. The jungle does however, confer some advantages on the defender:

- a. The density of vegetation helps to conceal positions from ground and air reconnaissance;
- b. Good cover affords ample opportunity for deceiving the enemy as to the exact location and strength of the defence;
- c. The defender will normally be familiar with the area, aware of available approaches and therefore in a position to surprise the enemy by fire and ambush;
- d. Once in position, the defender can remain quiet and undetected while the attacker invariably makes more noise moving through jungle;
- e. The jungle is a natural obstacle. Skilful use of the terrain supplemented by artificial obstacles, enables the defender to add materially to its stopping power.

PRINCIPLES

79. It is impracticable to hold a continuous defensive line in the jungle. The jungle favours an unusual type of mobile defence founded on a network of jungle bases between which troops should be able to move with relative rapidity undetected, and from which they can mount a series

of ambush positions in depth along the likely avenues of approach. The defence is thus deployed in depth parallel to the enemy's direction of advance, astride and along the sparse communications.

PREPARATION AND LAYOUT OF DEFENSIVE POSITIONS

80. The defensive battle should be pivoted on a series of small yet well protected bases from which mobile, aggressive elements operate to ambush and harass the enemy. Such bases may sometimes be best placed actually blocking approaches; however, in these circumstances they are difficult to conceal and are likely to be exposed to attack, especially from the air, thereby prejudicing their ability to dominate the adjacent jungle.

81. If time allows, bases should be positioned in the jungle itself within artillery range of the routes which must be covered. Each base commander should be given a tactical area of responsibility with the specific task of preparing suitable ambush positions in depth on vulnerable stretches of the likely approaches, backed by covered withdrawal routes along which ambushing elements can be supplied or reinforced from the base. A series of such bases, located in depth and each covering adjacent areas of responsibility, produces the structure of a defensive system by which control can be established Over the jungle through continuous and active patrolling: it also makes enemy movement along existing land communications a slow and expensive process.

82. The size and permanence of a base will vary according to the number of troops available and the time required for its preparation. A proportion should be fire support bases, each occupied by not less than a platoon of infantry with some artillery (anything between a single gun and a battery) which can not only bring down fire anywhere within their own areas but also mutually support other bases. Others may be FOBs housing a battle group commander, his tactical headquarters, and further artillery support. Infantry not required for local protection should operate from the base and be mainly engaged in active, aggressive jungle patrolling or in manning ambush positions. Helicopters are unlikely to be held permanently in fire support bases for security and logistic reasons, but they may use bases temporarily while in a liaison or reconnaissance role or when engaged in the task of moving reinforcements or supplies around the combat area.

83. It is unusual for armour to be present unless the base is close to adequate routes or open country. Although tanks could well be of value in a cut off or counter attack role in conjunction with an ambush, they are difficult to position quietly and are vulnerable to short range attack from behind cover if forced to withdraw. The anti-armour elements of such ambushes is best provided by hand held weapons.

84. Engineer elements may be included, if available, to assist in the construction of protective works and improvement of obstacles, in imposing delay at ambush sites.

85. A defensive layout in jungle must not be confined only to the selection of bases and ambush positions. Any potential enemy bypass and infiltration routes through each area of responsibility should be reconnoitred and plans made for covering them with sensors, backed up

by artillery support or fighting patrols. The more the covering elements can interfere with the enemy, the more difficulty he will have in locating and reducing the bases themselves and thereby maintaining his progress. The main tasks of the defending force will be:

- a. To gain information by patrolling on enemy strengths, routes, and the back-bone of the defence.
- b. Intensive patrolling from such jungle bases to gain intelligence.
- c. Reconnaissance elements and surveillance devices give early warning of an enemy approach along one or more routes. Ambush groups in or near preplanned positions are prepared for action, OPs alerted, and final road denial measures such as cratering, tree falling, or scattered minelaying are completed.
- d. Forward ambush groups bring direct fire to bear on enemy columns. Casualties are inflicted on the enemy's leading elements, who are pinned down and unable to advance further without calling on extra support.
- e. The enemy deploy dismounted infantry into the jungle to bypass or envelop the ambush position.
- f. Ambush groups may then either withdraw along covered routes, remain in position, or take up alternative positions from where they can harass the enemy's communications after he has passed.
- g. Enemy who succeed in striking the main route further along are either attacked in the rear by shadowing teams or bypassed ambush groups, or subsequently halted by further ambushes and forced to deploy once more into the jungle.
- h. The main enemy force, having cleared the obstacle, will resume its advance until again halted by a combination of more ambushes and road denial measures. The whole process of deployment, attack, and clearance of the route, which can be very laborious in thick jungle, has to be repeated.
- j. Enemy who have infiltrated deeper into the jungle now have tenuous and probably vulnerable communications and, if they are capable of mounting assaults against bases, they are subjected to interference from unexpected directions by mobile elements prepositioned near likely routes or moved to the area by helicopter or on foot from fire support bases.

87. Continual repetition of this process of ambush, harassment, and route denial will slow up the enemy so that his advance loses momentum. Those of his force which penetrate the jungle should be surrounded, attacked, and cut off from their sources of supply, while those still following the major axes of communication will find the process increasingly slow, frustrating, and costly. After a while, he may find it impossible to continue further, in which case, the immediate aim of the defence will have been achieved.

88. These defensive measures will make considerable demands on manpower and a commander will rarely have the numbers available demands on manpower provide patrols, defend bases, and form reserves on the scale he would wish. Priorities must be calculated for the various tasks and as a guide one third of the force might be allocated to each of the functions of defence of the base, external tasks (such as ambushes), and counter attack.

COUNTER ATTACK

89. Small, local counter attacks can achieve important successes against enemy penetrations between bases or defended localities. Each force of combat team strength should have a part of the force earmarked for this purpose.

SECTION 6

WITHDRAWAL

PURPOSE

90. The aim of withdrawal in jungle operations is to retain the cohesion and security of the force while imposing the maximum delay on the enemy. It may become necessary in the following circumstances:

- a. If the speed of an enemy advance along one or more routes threatens the stability of neighbouring areas and exposes them to unacceptable risk.
- b. If the enemy succeeds in eliminating the jungle bases on which ambushes and patrols rely for their support.
- c. If it becomes necessary to surrender control of an area of jungle and stabilize the situation on a major obstacle or in more open terrain.
- d. If friendly forces have accepted or are in danger of accepting undue numbers of casualties.

METHOD

91. Depending on the amount of enemy pressure, withdrawal may be carried out.

- a. Silently; this method should be adopted whenever possible.
- b. By fire and movement if under enemy pressure.
- c. By dispersal to a predesignated RV.
 - (1) This is usually only resorted to in an emergency or a dangerous and confused situation, but it can also be employed to avoid leaving a trail out of a position Or to confuse any enemy attempt to follow up.
 - (2) Troops should be given different general directions to disperse in, to avoid the natural tendency to bunch or follow someone else. It is quite feasible to disperse through the enemy.
 - (3) Once clear, each man should take a different detour to the RV, taking care not to lead the enemy into it. He should keep it under observation until he is sure that it is safe to enter.
 - (4) An alternative RV should always be included in orders and used if the main one is compromised. Subsequent withdrawal may be to a harbour when the force is to continue to operate in the same area, or by foot to a base or extraction point.

92. When evacuating a position or disengaging from the enemy, the most exposed groups should move first. In a withdrawal from an ambush position, this should usually take place in the following sequence:

- a. Warning and cut off groups.
- b. Assault groups.
- c. Command and killer groups.
- d. Protection groups.
- e. Rear protection group, sentries, and OPs.

93. The maximum use is made of surveillance and early warning, deception and ambush techniques and the maintenance of mobile patrols to monitor or harass enemy movement, slow his progress, and give the remainder of the force time to reorganize on a new series of bases and positions.

CONDUCT OF WITHDRAWAL

94. The jungle is ideal for breaking contact and carrying our rearguard actions with small bodies of resolute men who can inflict serious delay on a force many times their size. The timing of the withdrawal is, as always, important. Prolonged occupation of a defended area may lead to encirclement and while this may on occasions be acceptable, it will merely present unnecessary difficulties unless it makes a positive contribution to the success of the overall mission. A defending force should if possible always be withdrawn intact.

95. The main problem confronting a commander who is forced to withdraw is poor visibility, which increases the difficulty of keeping the enemy under surveillance and thus choosing the optimum time for a move. Contingency plans made before a withdrawal should include the reconnoitring of routes and assembly areas and, where time and the construction effort allows, the preparation of jungle bases in depth providing this does not compromise security. Where this is not practicable, temporary defended localities will have to be set up rapidly to accommodate artillery and provide a base from which mobile elements can operate.

96. Unless routes have been secured, withdrawal must be through the jungle, avoiding roads or tracks which the enemy can be expected to ambush. A night withdrawal will be exceptionally difficult under these circumstances and should only be resorted to in a dire emergency.

97. Heavy equipment is an embarrassment in a jungle withdrawal. Tanks and APCs are not suitable in a rearguard because of their relative immobility off routes and their vulnerability to ambush.

98. Information on enemy movement is vital to a commander in the withdrawal, and normal surveillance and target acquisition means may need to be supplemented by personnel who will provide intelligence by radio on the direction and strength of enemy movement.

99. Lateral routes assume increased importance during the withdrawal for the movement of reserves and ammunition from one threatened approach to another, particularly if helicopters are in short supply or the enemy has control of the air.

100. A jungle withdrawal should make full use of deception, surprise, and mine warfare. An imaginative commander can use the dense environment to confuse and frustrate the enemy, effectively concealing his locations and intentions. A well devised ambush system combined with the intelligent use of mines and booby traps can have an important psychological effect on the enemy, and engineers should be included in rearguard groups to assist with this.

101. Guns should be moved by helicopter from one fire support base to another whenever possible to minimize the length of time they are not in action while moving. Rearward bases should be prestocked with ammunition and other supplies. These will need protection from infiltrating enemy or guerilla forces.

LOGISTIC SUPPORT

102. During both defence and withdrawal, fighting elements must operate on the lightest possible scales and rely for additional resupply on centrally controlled helicopter borne supplies from forward operational bases and maintenance areas. A further helicopter task will be the evacuation of casualties.

SUMMARY

103. The basic principles of jungle defence can be summarized as follows:

- a. To retain control over towns for as long as possible by dominating surrounding jungle. This is achieved by forcing the enemy off the roads, tracks and waterways, and into the jungle, where his mobility, observation, and fire power is severely restricted.
- b. To make full use of the natural cover to conceal positions from ground and air attack.
- c. To adopt an aggressive, all round defensive posture at all times, accepting that the enemy will frequently infiltrate between and behind jungle bases.
- d. To deploy covering troops and surveillance devices to assist in early detection of the enemy, thereby preventing surprise and also enabling accurate fire by artillery and aircraft to be brought to bear before close contact is made.
- e. To use deception measures to mislead the enemy as to the precise location of the defence.

- f. To site positions in depth to counter infiltration, outflanking, or encircling moves, so that any attempted envelopment by the enemy exposes his forces and makes them vulnerable to defeat in detail.
- g. To shadow and monitor enveloping troops using both pre-laid sensors and mobile patrols, and to harass them by both direct and indirect fire.
- h. To improve natural obstacles by the intelligent use of mines and demolitions, while simultaneously making the existing routes difficult and costly to negotiate.
- j. To ensure the provision of alternative sources and methods of resupply should the normal ones fail.

CHAPTER 7

PARTICULAR OPERATIONS

SECTION 1

INTRODUCTION

PATROLLING AND AMBUSHING

1. The basics of patrolling are covered extensively in CFP 309(4), Patrolling. The techniques outlined here apply particularly to the jungle.
2. Ambush and counter ambush are covered in CFP 318(10). This will not be discussed further here.

SECTION 2

PATROLLING

GENERAL

3. Patrolling is the means by which a force dominates the jungle and as such it is the basis of jungle warfare. The reconnaissance and fighting patrols common to other theatres are all used in the jungle. However, a patrol which is of greater than platoon strength becomes unwieldy and difficult to control in jungle conditions. Should a larger force be needed, it should generally be broken down into smaller mutually supporting patrols each no larger than a platoon.

4. There should always be an overall patrol plan within which patrol tasks, boundaries, timings, and routes out and back should be carefully coordinated with flanking units to avoid any possibility of a clash.

5. Examples of suitable patrol tasks are as follows:

a. Reconnaissance patrols of up to four men:

- (1) To observe enemy or local habits and traffic.
- (2) To collect topographical information on tracks, rivers, obstacles, etc.
- (3) To select sites for bases, LSs, ambushes, RVs, assembly areas, etc.
- (4) To check that areas remain clear of the enemy and that minefields or other defence are intact.

b. Fighting patrols: within the limitations set out in para 2, a fighting patrol should be large enough and have the fire power to destroy any group of enemy it is likely to meet. They may be required:

- (1) To prevent enemy patrols gaining information or the initiative by aggressive patrolling and ambushing.
- (2) To harass the enemy and lower his morale.
- (3) To follow up the enemy after contacts.
- (4) To carry out raids and capture prisoners.
- (5) To maintain contact with flanking units and provide flank protection, and
- (6) To escort reconnaissance, supply, casualty evacuation, and working parties.

6. The remainder of this section explains the methods used by a small reconnaissance patrol when searching an area and collecting information of enemy positions. The techniques used can equally be applied to fighting patrols as they are part of the general skill associated with movement in the jungle.



Figure 7-1 A reconnaissance patrol following a stream bed

BASE LINE PATROLS (see figure 7-2)

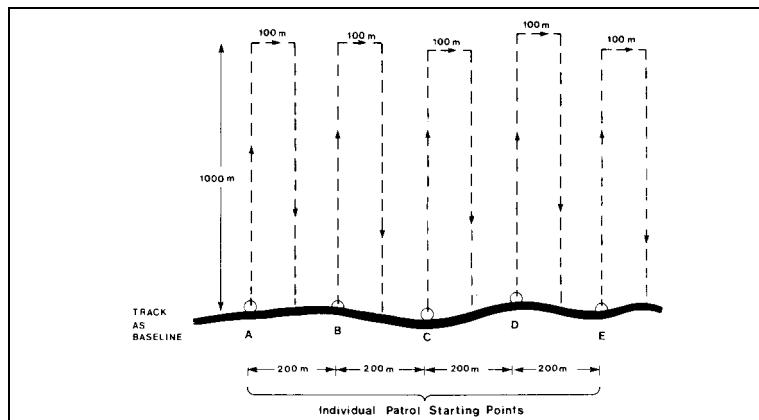

Figure 7-2 Base Line Patrols

7. This method ensures an even coverage across the grain of the area to be searched. Small patrols, usually of four men each, start at 200 m intervals along a base line which can be a ridge, stream, or track. Each patrol searches on a given bearing at right angles to the general direction of the base line for about 1 000 m, turns right for 100 m and returns to the base line on a backbearing.

8. In very close jungle or swamp, these distances should be halved, while in open jungle, although the interval between patrols should remain the same, they can normally cover 2 000 m

out and 2 000 m back if required. This method gives even coverages of the ground but suffers from the disadvantage that some patrols have much further to go along the base line than others.

FAN PATROLS (see figure 7-3)

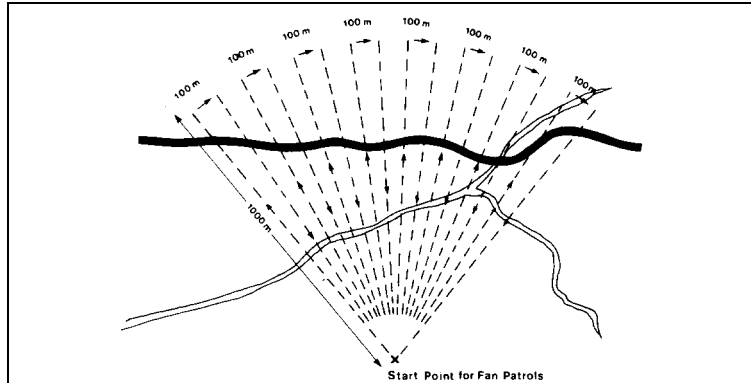

Figure 7-3 Fan Patrols

9. The requisite number of patrols leave the same start point on bearings at intervals of 200 mils, search for 1 000 m, turn right 100 m and return on a backbearing plus 100 mils.

10. Fan patrolling is easy to control at the start as all patrols leave from the same point; however, it does not cover the ground evenly and there is a considerable danger of patrols clashing as they return on converging bearings.

STREAM LINE PATROLS (see figure 7-4)

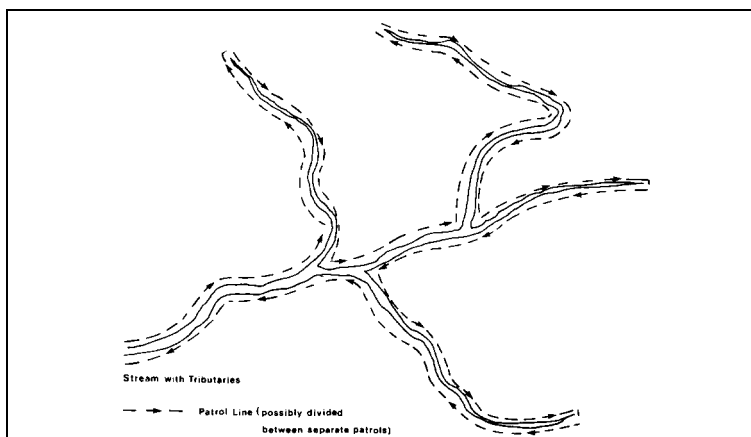

Figure 7-4 Stream Line Patrols

11. Each patrol works its way up and down a branch of a stream or creek.

12. This method is designated to discover enemy waterpoints or crossings. These patrols can be exhausting as jungle streams are either steep and rocky or wind through swamp and are usually densely overgrown. Stream line patrols may be ambushed by the enemy.

CROSS GRAIN PATROL (see figure 7-5)

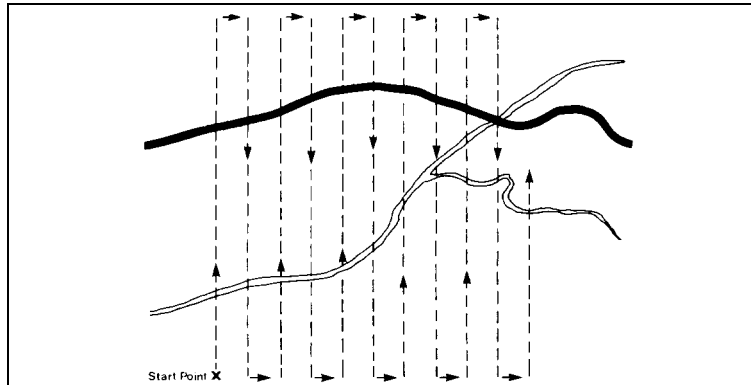

Figure 7-5 Cross Grain Patrol

13. A useful method of search, particularly in a large area, is to move backwards and forwards across the grain of the terrain. As this generally involves crossing routes rather than moving along them, there is less chance of an ambush. The ground is covered evenly by a single small patrol and there is no danger of clashing. The method is however, slow as it cannot be operated by a series of patrols except off a base line as in para 7, page 7-2.

PATROL TECHNIQUE

14. Reconnaissance patrols should be lightly equipped and should avoid contact with the enemy. Each patrol should carry a lightweight radio and possibly an optical or electronic aid to vision. The patrol should move slowly and silently through the jungle in two groups, each leap frogging past the other to, the limit of visibility. Every 10 minutes or 100 m, whichever is the less, they should stop and listen for about 5 minutes, sensing the atmosphere of the jungle, searching for unusual sounds and scents, and observing and interpreting the reactions of wild life.

15. Traces of enemy movement must be reported with details, where these can be recognised, of:

- a. the position;
- b. enemy strength;
- c. direction of movement; and
- d. time since enemy was present,

16. If detected by the enemy, the patrol should withdraw quickly under cover of smoke from a smoke grenade and fire from alternate groups as the others run past them for cover: the process being repeated until they are out of contact. Once clear, the patrol leader should report the contact by radio. The orders must state clearly whether the patrol is to follow up, return to base, or continue with the patrol.

17. Other patrols hearing firing should report:

- a. their own position;
- b. the time firing was heard;
- c. the bearing to the firing;
- d. the estimated distance; and
- e. The number and type of shots or explosions.

18. A reconnaissance patrol should be able to draw an accurate sketch map of enemy positions and obtain information in enough detail to enable a sound appreciation and plan to be made from it. If an attack or ambush is contemplated, the commander may decide to take part personally in the close reconnaissance or send his subordinate commanders. In any case, those who have done the close reconnaissance should play a major part in guiding the assault or ambush elements into position.

RECONNAISSANCE OF AN ENEMY POSITION

19. Once the patrol has located the enemy position, the patrol commander should select an RV where the remainder of his patrol can remain silent in all round defence. They must be briefed on exactly what he intends to do and the action to be taken should be either not return by a stated time or the RV be compromised. The commander should then take one man as an escort and circle the enemy position at 100 to 200 m distance to locate sentries and outposts. All movement must be extremely slow and cautious, with the commander and escort leapfrogging past each other to the limit of visibility. After each five minutes (or even less) they should stop and listen for about 10 minutes.

20. On the first circuit, sentries should be pinpointed and the best covered approaches noted; these approaches can then be used to crawl close to the enemy without being detected. It will probably be necessary to crawl in on several of these approaches before the necessary information has been gained. After each approach up to the enemy position the patrol commander must crawl back at least 100 m before moving round to make a fresh approach. Infinite patience and extreme caution must be exercised throughout the reconnaissance with frequent halts to listen; all tracks must be concealed. It is always easier to get close to the enemy under the cover of heavy rain.

21. If there is the slightest suspicion that they may have been seen or heard, the commander and his escort must freeze. If detected, whichever one has been seen should fire and throw a smoke grenade while the other runs past him to a second cover position and repeats the process until both are out of contact, when they should take a circuitous route to the emergency RV. If certain that they are undetected, the commander and his escort should continue with the reconnaissance. When it is complete, they should withdraw with great care, leapfrogging past each other until well clear of the enemy. Compass bearings must be checked continually, not only to determine their exact position, but also to ensure they run in the right direction if detected.
22. This type of reconnaissance of an enemy position is an exacting task and it will often be essential for both commander and escort to withdraw to a safe distance between approaches to the enemy position to snatch a short rest and make a sketch map and notes.
23. When this stage of the reconnaissance is complete, the commander and his escort should move to the RV by a circuitous route and brief the rest of the patrol so that each man has as much information as possible in case all do not return. The final withdrawal should be by a different route to that taken on the outward journey. During this move, each man must study the route to ensure that he can confidently guide a force back at any time in the future.
24. On their return, the patrol should be debriefed on a large scale model of the area.

FIRE SUPPORT FOR PATROLS

25. When fire support is available, it should be on call to patrols, who should be capable of adjusting fire if not accompanied by a fire controller. Care must be taken not to prejudice security by premature registration of targets. Patrols may request fire support to:
 - a. Extricate themselves from a difficult situation.
 - b. Support an attack, raid, or ambush.
 - c. Cut off or disrupt enemy reinforcements, and
 - d. Pin down the enemy and prevent his escape.



Figure 7-6 Fire Controller

CHAPTER 8

NUCLEAR AND CHEMICAL WARFARE

SECTION 1

EFFECT OF NUCLEAR WEAPONS

GENERAL

1. The previous chapters have described the jungle and its effects concluding with suggestions for tactical concepts in a non-nuclear war. The threat of nuclear war cannot, however, be overlooked and the increase in the number of nations with the potential nuclear weapons must add to the chance that these might be used in the jungle.
2. Nuclear weapons detonated in or over the jungle would cause widespread devastation and almost certainly make movement over large areas virtually impossible for both sides for some considerable time. The particular ways in which the effects of heat, blast, and radiation would be affected by the jungle are dealt with below. This chapter considers briefly the likely effect of nuclear weapons when employed in the jungle.

HEAT

3. The heat effect from the fireball of a nuclear explosion is significantly reduced by jungle foliage, particularly in primary, secondary, or deciduous jungle, all of which give useful protection to troops in the open. Fires are, however, likely to be started and in deciduous or bamboo forest, in the dry season, these may be widespread and cause casualties.

BLAST

4. The radius of effectiveness of blast is reduced to a considerable extent by jungle vegetation, the precise reduction depending on the height of burst and the size and nature of trees in the vicinity. However, the blast wave will blow down trees over a wide area and the missile effect of flying trees and branches is likely to cause more casualties to unprotected personnel than the initial blast wave itself: in primary jungle, where the trees are tallest, this secondary effect could well prove to be the most lethal consequence of a nuclear explosion.
5. A further effect of tree blowdown will be to turn the jungle floor into a chaos of fallen, splintered trees and branches and a mass of tangled undergrowth. A wide area around ground zero will be impassable to any form of vehicle and even foot movement will be slow and tortuous. Vehicles trapped in the area if still serviceable and undamaged may be unable to extricate themselves and will have to be abandoned unless engineers can clear a path or support helicopters can lift them out. Troops trapped in jungle after a nuclear explosion will also be extremely vulnerable to further air or artillery attack by the enemy because of their lack of mobility.

NUCLEAR RADIATION

6. Immediate. Gamma radiation is reduced by wood and to some extent by dense vegetation. The shielding effect of primary jungle, with larger trees but relatively little undergrowth, is therefore greater than that likely to be provided by secondary growth.

7. Residual. The quantity of residual radiation reaching the ground in jungle shortly after a ground burst will generally be far less than in more open areas, as a high proportion of radioactive fallout will land on the less chance of significant residual radiation at ground level. However, rain will eventually wash these particles to the ground, where they will continue to be active until dispersed or decayed. Radioactivity is thus likely to be concentrated in areas where water collects and all streams and waterholes in the area are almost certain to be affected.

SUMMARY

8. The secondary effects of heat and blast, in the form of fires and tree blowdown, the main threat from nuclear weapons in jungle. Blast effects in particular are likely to produce chaos and will reduce ground mobility to a minimum. Providing troops are well dug in, they will be better protected than in open country. The dangers of radiation are considerably less than in open country, although sources of water may be denied for long periods by the effects of residual radiation. There will be a heavy demand for helicopters after an explosion to lift in medical stores and supplies, evacuate the most serious casualties, re-establish command and control, and determine the extent of damage.

SECTION 2

CHEMICAL THREAT

GENERAL

9. It is the policy of the Canadian Government not to initiate the use of chemical agents. A knowledge of the methods of offensive use of chemical agents by an enemy is, however, of fundamental military concern and is essential to the preparation of suitable defensive measures. Mention of chemical weapons is made in this pamphlet, therefore, solely in order that the full tactical implication of their use by the enemy may be studied.

10. Under a chemical threat, it will be the responsibility of the field commanders to decide when the troops are to put on chemical warfare (CW) protective clothing and masks or put into operation collective protection arrangements for vehicles. When this stage has become necessary, extra burdens will be placed on the soldier because of the additional heat load and breathing resistance. Although training and familiarization will help to overcome these problems, extra time must be allowed for the conduct of operations. If persistent agents are used, arrangements should be made to allow troops to be relieved to rest, feed, and change contaminated clothing.

CHEMICAL EFFECTS

11. The temperature, humidity, and lack of wind prevalent in most areas of rain forest make it an extremely suitable environment for the use of chemical agents. A considerable vapour concentration of persistent agents, both in the air and in the form of droplets trapped in the vegetation, lasts for very much longer than in the cooler and drier conditions found in temperate climates. Non-persistent agents also last longer than usual.

12. The density of the jungle canopy will, however, impair the effect of chemical agents delivered by airburst weapons or aircraft spray, as only a small proportion of the agent will reach the ground. Bombs and artillery projectiles filled with a toxic agent will therefore, be most effective if fitted with delay fuses.

13. Military Effects. The effects of chemical agents on ground forces in jungle will be twofold:

- a. The mere presence of an active threat of the use of chemical weapons by the enemy may well require troops to live in protective clothing. Worn for even short periods in climatic conditions normal to the jungle, the clothing becomes uncomfortable and reduces efficiency, and the mask, though likely to be worn only in the event of actual attack, restricts the soldier's senses and also reduces his effectiveness considerably.
- b. The persistence of some agents could mean that an area might be denied to troops not equipped with protective clothing for weeks or even months after chemical attack, and military operations in such an area would certainly be restricted for some time. Such weapons could possibly be used merely to deny the few major avenues of approach

through a jungle region during a defensive action, regardless of whether enemy are actually in the area at the time. Subsequent advance along such approaches naturally poses a hazard to the forces using these agents, although, providing full protective measures are taken, this should not present great difficulty.

14. Defoliation. This is the killing off of jungle foliage by chemical means. It is a long term process, has no immediate effect, and is therefore unsuitable for fast moving operations: the leaf may not wither away completely for about two weeks after application. It is not normally permanent, as most trees recover some 12 months later and respraying is necessary if continuing results are required. Defoliation will despoil cultivated areas, rubber plantations, etc, and its use may therefore have to be restricted in friendly areas.

a. The aim of defoliation may be one of the following:

- (1) To expose permanent enemy defences, bases, and installations hitherto concealed beneath the jungle canopy.
- (2) To clear the sides of roads or waterways of jungle and thus reduce the risk of ambush.
- (3) To strip whole areas of jungle of leaf and so deny the enemy the advantage of cover.
- (4) To clear and open fields of fire around our own defensive positions, and
- (5) To destroy enemy crops.

b. To be effective on undergrowth, defoliant should be introduced beneath the canopy either by spraying from aircraft, ground spraying, or by shells and bombs. It may be necessary to punch a hole in the canopy by bombing prior to spraying through the gap.

c. The time of year relative to the growing season, the prevailing temperatures, and the rainfall will all be factors affecting the decision on whether and when to apply this chemical. The early morning and the evening are generally the most favourable times for spraying.

EFFECT OF JUNGLE ON PROTECTIVE CLOTHING AND EQUIPMENT

15. Protective clothing and radiac equipment is liable to deterioration in the moist jungle conditions. Storage areas should be dry and, where possible, air conditioned. Frequent checks will be necessary to ensure that the equipment is serviceable.

SUMMARY

16. The use of chemical agents in jungle is favoured by the sparse population, high humidity, and lack of wind which together make their use less risky than in more developed areas of the world. All agents are more persistent than in temperate climates. Accurately placed, truly

persistent agents could be most effective in denying an area to full scale military operations for a considerable time. Defoliation agents may be used by attacker and defender alike.

CHAPTER 9

TRAINING

SECTION 1

INTRODUCTION

AIM OF JUNGLE TRAINING

1. The aim of jungle training is:
 - a. To become acclimatized.
 - b. To acquire an understanding of the jungle and the ability to exploit its characteristics to one's own advantage.
 - c. To acquire proficiency in the jungle skills and drills.
 - d. To emphasize the importance of junior leadership and improve its quality.
 - e. To attain a high standard of marksmanship and fieldcraft.
 - f. To foster self reliance and individual leadership.
2. The following phases of training may be useful as a guide:
 - a. Instructor training. This may take about six weeks if suitable facilities are available and if potential instructors are well motivated.
 - b. Specialist training. This includes training extra medical orderlies, dog handlers, specialist search teams, and can be done while instructor training is taking place.
 - c. Individual training. This lasts perhaps three weeks.
 - d. Unit training. Progressing from section level up to battle group, this is unlikely to be completed in less than five weeks.
- 3.a. With the exception of acclimatization, the early phases of training can be carried out in any thickly wooded area. If these are complete before a unit arrives in the theatre, fewer training facilities will be needed at that stage and units can go straight into the jungle to acclimatize and work up skills, technique, and tactics.
- b. The remaining phase can only be completed effectively in the jungle and can take about four weeks. The effectiveness of the training can only be tested by ultimately conducting

operations against the enemy. Where this proves more training is required, it should be given.

ACCLIMATIZATION

4. At whatever stage in training troops arrive in a jungle theatre, the sequence of instruction need not be broken to acclimatize. Physical exertion in the heat is an essential part of the process and the jungle is an easier environment in which to acclimatize than open areas exposed to direct sunshine.

5. During acclimatization, the tempo of training should be reduced to walking pace for the first few days, gradually building up to full physical activity in about two weeks. Officers and NCOs must keep a careful watch for and deal promptly with any cases of heat illness. When acclimatized, a man sweats more freely but his sweat does not contain so much salt. During acclimatization, water intake must not be restricted and salt must always be added if the intake exceeds 7 litres daily; below that level, enough salt is contained in the diet. Thirst is not a good indicator of fluid requirement and more should be taken than thirst dictates.

6. It is important that any battalion likely to be employed in the jungle should have a nucleus of instructors which should preferably not be less than two officers per battalion and one senior NCO per company, a battalion which has been warned for operations will need as many instructors as possible and a suggested scale of these and of other specialists is as follows:

a. Jungle Warfare Instructors.

(1) One officer instructor per company and battalion HQ.

(2) One officer instructor per support weapon platoon.

(3) One NCO instructor per section and each HQ.

b. Patrol Medical Orderlies and Radio Operators. One per section and each HQ as well as reserves.

c. Dog Handlers. One per company and battalion HQ or four for the reconnaissance platoon.

d. Visual Trackers. It would be ideal for six men per company and battalion HQ, or alternatively the whole reconnaissance platoon to be trained in this role; however, the number will generally be limited by the scarcity of those who have the rare natural flair for tracking,

e. Helicopter Rigging. One officer and two senior NCOs trained.

INDIVIDUAL TRAINING

7. The aim of individual training is to teach troops to master the techniques of living, moving, and fighting effectively in the jungle. Stress must be placed on the importance of the individual soldier reaching a high standard of skill and self reliance before he can take part in more advanced jungle training.

8. Orientation. Soldiers should be introduced to the theatre and their operational role with instruction in the following subjects, augmented by visits, demonstrations, films, etc:

- a. The environment, population, religious customs, and the economy of the countries concerned.
- b. The political and military background.
- c. Enemy organization, equipment, methods, and motivation.
- d. Jungle warfare, organization, equipment, and the concept of operations.
- e. Security, intelligence, and psychological warfare aspects and their bearing on the behaviour of troops towards both the enemy and the local population.

9. Health and Endurance. Jungle warfare demands physical and mental toughness to combat the climate, the jungle, the enemy, and disease. Troops must be fit before arrival in the theatre and continue to build up their strength and endurance as soon as they have acclimatized. Endurance training must not be allowed to slacken off after acclimatization or during breaks in training and operations. Swimming should be encouraged as a recreational activity and included in the training program. Health precautions should be taught and enforced and all must be instructed in first aid as early in the program as possible, stressing heat exhaustion, snake bite, and gun shot wounds.

10. Jungle Skills. The subjects to be taught are:

- a. Navigation.
- b. Concealment.
- c. Observation.
- d. Tracking.
- e. Living in the jungle, and
- f. Survival.

11. Skill at Arms.
 - a. Major emphasis must be devoted during jungle weapons training to developing and instinctive ability to shoot quickly and accurately at unexpected fleeting targets by day and night. Engagement from any position, firing two quick aimed shots from the shoulder, round and not over jungle cover, must be the aim. (Refer to CFP 318(6).)
 - b. Most jungle contacts take place at close range and the good infantry shot usually experiences no difficulty in adapting his reflexes to jungle shooting, providing the transition is taken step by step. The first essential is to improve the weaker shots until they can group in the killing area of a figure target, from any position, from about 30 m. Until this can be achieved, there is no point in progressing on to jungle ranges.
 - c. Training should continue on jungle ranges and should progress to cover the transition from stationary to moving targets.

UNIT TRAINING

12. The three-section platoon is the optimum-sized basic fighting unit in the jungle. An identifiable concept of operations begins to materialize at combat team level, where the activities of a number of platoons can be coordinated to dominate an area of jungle. Some suggested exercises for the combat team against a small enemy are:
 - a. Patrolling. Combat team HQ and supporting arms man a fire support base while each platoon searches an area.
 - b. Ambush. Separate platoon or smaller ambushes are coordinated to form a combat team or larger area ambush.
 - c. Attack. This gives scope for including more than one combat team. Fire from one or more combat team fire support bases can be coordinated (with air strikes and armed helicopters) to support an attack. Platoons (which can include engineer and armoured elements) assault a series of objectives; further platoons, possibly from another combat team, providing reserve assault, mobile reaction, follow up or cut off groups; while platoons from a third combat team set up a cordon of ambushes on likely enemy escape routes.
13. Although there is always scope for improving individual skills, the emphasis during sub-unit training should be on junior leadership and the tactics required to survive in and dominate the jungle.
14. Although cadres are useful to improve the knowledge and ability of junior leader, the best possible training they can receive is to be given full responsibility for their group under all conditions of both training and operations.

15. The drills already described in previous chapters must be taught and practised, initially at section level, then by platoons and larger units, including supporting arms, until they become automatic.

JUNGLE TACTICS

16. The most rewarding low level jungle tactic is the ambush and all tactical training and operations should be directed towards ambushing the enemy at every opportunity.

17. Each stage of training should be taught and practised separately at platoon level, with frequent day and night live firing practises on jungle and field firing ranges.

18. Platoon training should culminate with two-sided exercises incorporating the full sequence of operations gradually building up to combat team level.

SPECIALIST PLATOONS AND SUPPORTING ARMS

19. In some circumstances, supporting arms may be required to act exclusively as infantry, whereas in others, they may be employed in their conventional role. The degree of adaptation which they and specialist platoons may need to undergo to fit them for jungle operations, once basic infantry jungle training is completed, will depend on:

- a. The type of enemy.
- b. The terrain, and
- c. The scale of operation

BATTLE GROUP TRAINING

20. Once the various tactics, techniques, and drills applicable to jungle warfare have been learnt and well practised at combat team level and below, composite unit training should concentrate primarily on command and control. Exercises should be designed to perfect the control and coordination of a number of dispersed subunits, platoons, and sections over a wide area of jungle during the various phases of conventional operations or the many and varied situations likely to be met in counter revolutionary operations. Communications, security, speed of reaction and redeployment, and efficient supply arrangements should all be practised.

SECTION 2

AIDS TO TRAINING

JUNGLE LORE LANES

21. The enemy will almost certainly be at home in the jungle and able to use its characteristics to his own advantage. A comparable degree of skill can be acquired by our own troops who must be trained to achieve a degree of knowledge that may well be second nature to their opponents. A jungle lore lane is one of the aids which can be used in this training and some suggestions on how one might be laid out are included in Annex C.

JUNGLE RANGES

22. The quick reactions and high standard of marksmanship which are essential attributes of the well trained soldier and which are vital to the success of jungle operations can only be acquired by constant practice in realistic conditions. An imaginatively laid out jungle range simulating a variety of possible jungle situations, which can be easily and quickly changed to avoid repetition and maintain operations can easily be constructed in a wooded area. Suggestions for such a range are in Annex D.

JUNGLE WARFARE INSTRUCTORS' COURSE

23. Training for jungle operations requires a wide new range of skills to be taught to all ranks and consequently the training of a cadre of unit instructors in jungle warfare. These instructors can only be fully trained in a jungle environment and the facilities for their training should be established well in advance of operations. In the absence of an established jungle warfare school, a suggested outline program for a six weeks' course has been included in Annex E to assist in the planning of such training.

JUNGLE AIDE-MÉMOIRE

24. An aide-mémoire which includes a wide range of points relevant to jungle warfare set out under the headings used in orders has been included in Annex F. This annex may be useful during training, when planning an operation, when preparing orders at any level, when laying out a base or when engaged in any other operational activity in the jungle. It is long because it seeks to be comprehensive and it is detailed to make it applicable at all levels.

ANNEX A

USE OF DOGS

INTRODUCTION

1. Although dogs are not presently used in the Canadian Forces, the information on their use is included for guidance and reference.

GENERAL

2. Because of their highly developed sense of smell and hearing, dogs can be a valuable asset to infantry and particularly to patrols on jungle operations. To obtain maximum value from them, it is essential to understand the conditions best suited to their employment. Outside influences have a direct bearing on their behaviour and dogs cannot be expected to work at full pitch under all circumstances. Where the handler is thoroughly familiar with his dog and appreciates its limitations, an effective team results.

3. Dogs are trained by special instruction. Dog handlers are members of the unit and are sent away for initial training and then return to acquire experience with their unit. The standard of efficiency of operational dogs can only be maintained and improved by regular continuation training and specialist NCOs should from time to time be attached to units for this purpose.

4. Dogs are employed on jungle operations as:

- a. Tracker dogs (usually Labradors).
- b. Infantry patrol dogs (usually Alsatians).
- c. Specialist dogs which may be of any breed and are used for such tasks as searches for explosives, drugs, weapons, mines, etc, and tunnel detection. As the principles of their employment are similar in all types of country, they are not considered further.

THE TRACKER DOG

5. Roles. The main role of the tracker dog is as part of a Combat Tracker Team (see Annex B) to follow up or seek out the enemy. The dog can also help find lost or missing individuals or patrols.

6. Method of Working

- a. The dog tracks a combination of scents given off from the body and clothing of an individual together with those released by the bruising of vegetation or the crushing of insects. This combination is known as the track picture.

- b. The track picture is specific for an individual or group of individuals. Once a dog has started to track, it can differentiate between the scent of the quarry and the scent of other people or animals that may cross the track.
- c. The dog becomes conscious of the scent through the air it breathes coming in contact with the membranes lining the nose. It follows that the degree of discernment is directly related to the concentration of scent in the air. This concentration varies with the rate of evaporation, air movement, and type of country over which the track is made.
- d. The dog is not trained to be vicious, but rather the reverse, and is required to remain quiet at all times.
- e. Tracker dogs can most usefully be employed in the combat tracker team unit, but provided units are aware of their capabilities, dogs can be employed outside this unit.
- f. No soldier should be permitted to work a tracker dog until he has been trained to handle that particular dog. The dog may well be a liability in untrained hands and its training and further usefulness impaired.

7. Capabilities

- a. The tracker dog can commence tracking:
 - (1) From the scent of a footprint, disturbed ground, or an article dropped by the quarry.
 - (2) By being cast over the area from which the quarry have made their escape and picking out the freshest scent.
 - (3) By being cast straight onto the identified track of the quarry. Under reasonable conditions, a dog can generally commence tracking on a 24-hour old scent and follow it over varying terrain. The fresher the scent, the larger the number of quarry and the faster they attempt to escape, the greater the chance of success. The most important single factor is time. The dog should be brought to the scene of the incident as quickly as possible and not used as a last resort. Dogs may be held centrally until their services, are required.
- b. The movement of troops in the area of a contact must be restricted as soon as the decision to employ dogs has been taken: trampling over the track will interfere with the dog's chances of picking out the track of the quarry.
- c. Scenting conditions are notoriously unpredictable but generally speaking, the factors that increase the dog's chances of success are:
 - (1) Ground temperature warmer than that of the air.
 - (2) A mild humid day with slow evaporation.

- (3) Ground overshadowed by trees.
 - (4) An unclean enemy.
 - (5) A track over virgin ground.
- d. Factors which adversely affect the track picture include:
- (1) Heavy rain.
 - (2) Strong wind.
 - (3) Hot sun with rapid evaporation.
 - (4) Crowded areas.
 - (5) Running water.
- e. A tracker dog should be fit enough to work a track for two days. It can track by day and night. At night tracking is difficult because the handler cannot see and read his dog.
- f. Under favourable conditions, the dog will indicate silently to its handler when it is nearing the quarry. Once the dog has given such an indication, it has completed the task for which it has been trained and should be taken off the track.
8. Limitations. A tracker dog is not a machine and must not be treated as such. The following are some of the limitations on the use of a tracker dog:
- a. In very hot and trying conditions, the dog may want to leave the track temporarily to seek shade or water.
 - b. When required to work a track for long periods under difficult conditions, or if the pace is slow, the dog may lose interest. The team commander should always try to set an even speed rather than an alternating or an over cautious; slow pace.
 - c. The handler must carry rations for his dog, which will be in the region of 1.5 kg a day, as well as for himself.
9. Handler Information. Before a tracker dog can start to work on a track, the handler requires certain information:
- a. He must know:
 - (1) Where the quarry was last-seen, and
 - (2) In which direction it was moving.

- b. He should know:
 - (1) The amount and the limit of movement by friendly troops which has taken place in the area where the quarry was last seen.
 - (2) At what time the quarry was last seen.
 - (3) How many there were.
 - (4) Whether it is thought that there has been movement, by the quarry, out of and back into the area where the track starts before final departure.
 - (5) The state of the weather after the quarry was seen.
 - (6) The probable reaction of the quarry when encountered, and
 - (7) The composition of the follow up party, including the man who is to act as the dog handler's coverman.

INFANTRY PATROL DOG

10. Roles. The patrol dog can be used:

- a. On reconnaissance and fighting patrols.
- b. As a sentry outpost, and
- c. In ambush positions.

11. Method of Working

a. A patrol dog differs from a tracker dog in that it does not follow a track but it is alert to the scent of human beings or animals conveyed to it on the air or by hearing (see figure A-1), It is trained to give silent warning by pointing. The patrol dog is therefore, useful for giving silent warning of ambushes and attempts at infiltration, and will indicate any presence before it can be detected by a human. The distance at which warning is given depends on the following factors:

- (1) Wind direction and velocity.
- (2) Prevailing weather conditions.
- (3) Density of vegetation, and
- (4) Individual ability.



Figure A-1 An Infantry Patrol Dog

- b. Infantry patrol dogs are normally worked on a long lead both by day and night, although some dogs can be worked off the lead by day only. In all cases, the dog is under the direct control of its handler.
 - c. Dense vegetation impedes the movement of air and reduces the distance at which the dog can indicate a foreign presence: it may, therefore, sometimes be advantageous to work a dog loose in jungle during daylight when moving along tracks.
12. Limitations. The survival of a patrol may depend on its ability to locate an enemy without itself being detected: a trained patrol dog will always detect a hidden enemy before the patrol. The dog can be worked by day or night in most kinds of weather and country and is not disturbed by the noise of battle. Certain limitations must, however, be stressed:
- a. The dog's performance usually deteriorates in heavy tropical rain and when working upwind of the enemy.
 - b. Dense, trackless secondary jungle is difficult to negotiate and lowers his efficiency.
 - c. He is apt to become perplexed when a lot of activity is taking place within a small area.

- d. He cannot differentiate between the enemy and own forces. Full briefing of the patrol on the dispositions of our own troops is therefore, essential.
- e. He will point at animals such as monkeys and pigs, but the handler should normally recognise a false point of this kind.
- f. As for the tracker dog, the handler must carry rations for his dog as well as for himself. On protracted operations without resupply, this can mean a considerable increase in the handler's load.

13. Patrols. On patrol, the handler and dog should lead. The normal procedure is:

- a. The patrol commander briefs the handler on the mission, disposition of own troops, the general direction of advance, and any special instructions before moving out.
- b. The patrol dog and handler, with one escort armed with an automatic weapon, precede the patrol at a distance close enough for immediate communication with the patrol commander. At night, this would be at about arm's length, in daylight the distance will be greater but still within visual signalling distance. The dog and handler should be allowed to take advantage of any wind or other conditions which will help the dog's scenting powers.
- c. When the dog points, the handler indicates by silent hand signal and the patrol takes cover.
- d. The patrol commander should then move quietly up to the handler and make his plan.

14. Sentry Outposts. A patrol dog can give timely warning of the approach of the enemy. The handler and dog are placed a short distance from other men, within visual distance in day-light but much closer at night. A simple means of communication between handler and patrol commander at night is a piece of cord. When alerted, the patrol commander should proceed immediately to the handler to find out the distance and direction of the enemy.

15. Ambush Positions. In ambush positions, especially at night, the dog will give warning of anyone approaching. The handler should choose an advantageous position in regard to wind direction and he must always be beside his dog.

DOG HANDLERS

16. The performance of a war dog is directly dependent on the skill of the handler and the mutual understanding existing between them. Potential dog handlers should always be volunteers who have already received a sound basic military training and who are friendly and sympathetic towards dogs. A dog will quickly sense an unsympathetic handler and its standard of performance will deteriorate. Other qualities for potential handlers in jungle operations are as follows:

- a. Intelligence, ability to learn, patience, and perseverance.
- b. Good eyesight.
- c. Physical fitness; handlers must be able to keep up with their animals, and
- d. Responsibility; the handler bears the responsibility for his dog seven days a week, not only when the dog is fit and working well, but also when not actively employed or sick. He is also responsible for ensuring that the animal is kept up to standard in both basic and specialist training.

17. Training for tracker and patrol dog handlers may take over 12 weeks, and periodic refresher training for both dogs and handlers will be necessary. A handler must always be given enough time for the proper care, management, and continuation training of his dog and the substantial benefits obtained will more than compensate for any trouble and inconvenience.

ANNEX B

THE COMBAT TRACKER TEAM

INTRODUCTION

1. The respective capabilities of the visual tracker and the tracker dog are complementary; they can with advantage be combined into composite teams known as combat tracker teams. Such teams have played an important part in counter revolutionary operations and can be of considerable value in any type of war where the terrain affords good concealment.

ROLE AND CHARACTERISTICS

2. The main role of the team is to follow up the enemy and re-establish contact. They can also be used to:
 - a. Detect enemy ambush or other positions and patrols.
 - b. Track down groups of enemy detected by air or ground observers, inhabitants, or sensors.
 - c. Find lost or missing individuals or patrols.
 - d. Gain information on going or tracks, and
 - e. Teach the principles of visual tracking to other soldiers particularly infantry section commanders and scouts.
3. The respective merits of dogs and visual trackers are:
 - a. Dogs. They can track quickly by day or night over terrain where no visible sign is apparent and indicate the presence of a hidden quarry.
 - b. Visual Trackers. A man can talk and thus report on his findings; he tires less easily than a dog although he cannot track as quickly. He can help to put a dog back on the track which the latter may have lost.

ORGANIZATION

4. A combat tracker team should be a closely knit group of five or six with permanently affiliated visual trackers and a team commander, signaller, dog, and handier. The composition and equipment of the team will vary with circumstances, but at least one member should also be a trained patrol medical assistant and they must all be issued with light weight weapons, rations, and equipment. They should be equipped with a long range, light weight radio and will have to carry rations and possibly water for the dog.

CONDUCT OF OPERATIONS

5. Teams should normally be held centrally under the control of the unit operations officer and one should always be at immediate notice to move by the fastest means to the scene of a contact or incident. As soon as a team is called out, the next team should be stood to and transport alerted. Where helicopters are available and no suitable landing point exists, the team (including dogs) can be lowered on a rope or winch. The team can protect itself and may risk limited offensive action, but its task is to find an enemy, and it should therefore, always be accompanied by a support group who can fight the battle once the enemy is located.

6. The sequence of events from the time the team is called out should be:
 - a. Team commander briefed on the situation, mission, transport RV, and contact on arrival.
 - b. Preliminary briefing of the team by the commander and move to the RV.
 - c. At the RV the local commander gives a further briefing with information about the enemy, friendly troops, and any limits to movement: he also details the support group.
 - d. After coordinating the plan (including any available fire support) with the supporting group commander, the tracker team commander briefs his team.
 - e. The track is started.
 - f. When the dog points, or a visual tracker sees enemy or a very fresh sign, the team stops tracking and calls the support group commander forward, who carries out a reconnaissance and makes a plan in conjunction with the team commander.
 - g. The support group deploys to destroy the enemy.
 - h. After the action, the team should either help search the area or, if all known enemy have not been accounted for, resume tracking.

7. The following are tracking formations which may be selected according to the terrain:

- a. Close Jungle

- (1) Dog Leading

Dog and handler

Cover man

Team commander

Signaller

Cover man

Cover man

(2) Visual Tracker Leading

Visual tracker

Cover man

Team commander

Signaller

Dog and handler

Cover man

b. Clearings or Open Areas.

(1) Dog Leading

Dog and handler

Cover man

Cover man Cover man

Team commander

Signaller

(2) Visual Tracker Leading

Visual tracker

Team commander

Cover man Cover man

Dog and handler

Signaller

8. As soon as a visual tracker loses the track or the handler suspects that his dog is not tracking, the team commander should decide whether to cast the dog or search for signs. In the latter case, trackers with a cover man should carry out the proper search procedures.

9. When the team needs to stop to rest, eat, or send a situation report, they should halt the support group and track on to ensure no enemy are in the vicinity before returning to the selected halt or harbour area. Meals should be taken during these halts. Tracking should start early in the morning in an attempt to catch the enemy in their overnight position, and it should continue in the evening until it is too dark to see a sign. No morning rest should be taken until after the time when the enemy can be contacted where he halted for the night.

REPORTING

10. When tracking, a routine report should be sent by radio in the following form at designated intervals:

- a. Grid reference.
- b. Time of arrival.
- c. Number of enemy being tracked.
- d. Age of track.
- e. General direction taken by the quarry.
- f. Planned time of departure, and
- g. Additional information.

11. A contact should be sent in the following sequence whenever enemy are located:

- a. Grid reference.
- b. Time of contact.
- c. Own casualties.
- d. Enemy casualties.
- e. Description and number of enemy.
- f. Direction taken by quarry.
- g. Planned time of departure, and

- h. Additional information.

TRAINING

12. Every member of a combat tracker team must be a trained visual tracker and have completed basic jungle training. In addition, at least three members of each team should have received prior training as a dog handler, signaller, and patrol medical assistant respectively. They should take part in all jungle training as a team, with special emphasis on:

- a. Physical Fitness. The duration of a team depends on its fitness: training time must be devoted to progressive and arduous physical training.
- b. Tracking. Visual and dog tracking exercises incorporating observation tests should be carried out at least twice a week, with the length and age of track being varied on each occasion.
- c. Shooting. The team should carry out frequent and progressive jungle range shooting practices by day and night (see Annex D).
- d. Helicopter Training. Deploying and roping-in drills must be practised with the helicopters and crews likely to be involved in a team lift.
- e. Navigation and Radio Operating. Every member must be capable of navigating and of operating the team radio and be given the opportunity to practise regularly.

ANNEX C

JUNGLE LORE LANES

INTRODUCTION

1. Jungle lore lanes are designed to teach jungle craft and techniques to individual soldiers while simultaneously developing their powers of observation, interpretation, and quick reaction. Lanes should contain a number of stands or incidents sufficiently far apart along a jungle track not to interfere with one another.

COMPOSITION

2. Stands should provide a variety of examples of enemy, friendly and, where appropriate, local signs and activity. Where applicable, they should be activated to produce the smells of fires, cooking, medicines, toilet items, and human and animal scent; they can also be used to convey an impression of the noises of both careful and careless movement, talking, whispering, cutting, and the carrying out of routine tasks such as cleaning weapons, digging, and operating a radio.

3. Genuine animal, bird, insect, or other noises should be explained and compared with imitations, especially those used by the enemy, local inhabitants, or friendly troops. The correct and incorrect use of camouflage techniques can be brought out at appropriate stands.

4. The following lessons should be included in one or more lanes:

a. Age of Sign. About once a week, a set of different types of sign should be made to one side of the track and labelled to show the date they were made and the type of weather they have been exposed to since. The following could be included:

- (1) Footprints made by various footwear and bare feet.
- (2) Traces of blood.
- (3) Broken and cut branches.
- (4) Cigarette ends, packets, and matchsticks.
- (5) Wrapping paper, empty tins, and waste food.
- (6) Excreta.
- (7) Spent cartridge cases and other ordnance, and
- (8) Fireplaces and shelters.

- b. Booby Trap Lane. Booby traps, mines, and similar devices, together with enemy methods of marking them, should be set so that they initiate a thunderflash or length of instantaneous fuse when sprung. Those that cannot be activated harmlessly should be placed to one side of the track and protected by a fence.
- c. Survival Lane. The track should be sited to pass labelled varieties of edible, useful, and poisonous plants interspersed with water sources, animal, bird and fish traps, snares, shelters, methods of making fire, and potential cooking utensils.
- d. Immediate Action Circuits. Lanes incorporating enemy sign posts, warning devices, tree and ground sentries, snipers, ambushes, and patrols are essential to practise immediate action drills. They should include a properly dug enemy defensive position with bunkers, a tunnel system and typical defences as well as examples of camps, caches, hides, and post boxes. Methods of distracting attention, such as pulling a string attached to a bush some distance from a sniper, should be demonstrated.

CONSOLIDATION

- 5. Once troops have obtained maximum value from individual lanes, the latter should be changed, becoming progressively more difficult and being combined with a jungle shooting lane to portray realistic situations and test soldiers' reactions and initiative.

ANNEX D

JUNGLE RANGES

AIM

1. Jungle ranges are designed to teach soldiers to shoot quickly and accurately at unexpected, fleeting targets in the jungle by day and night.

METHOD

2. Soldiers must be taken step by step from grouping on stationary figure targets to firing on jungle lanes and ambush ranges, culminating in live firing exercises on field firing areas, where jungle battle conditions can be accurately simulated. Sufficient ammunition must be allocated for each man to keep practising each stage, until he can score at least half the possible number of points, before he is allowed to progress to the next practice. Once soldiers have reached this standard by day, the same practices should be carried out at night at ranges up to the limit of night vision, with and without aids, and with night lighting. The stages are:

- a. Zeroing.
- b. Grouping.
- c. Funfair.
- d. Snap.
- e. Moving target.
- f. Jungle lane.
- g. Ambush, and
- h. Field firing.

SITING

3. All ranges must be sited in jungle to create the right atmosphere and lighting. Danger areas can be reduced considerably by firing into jungle re-entrants. Otherwise, the full danger area for each weapon must be cleared or fall within a prohibited area.

4. Range Areas must be large enough to allow each type of range to be moved as soon as a patch of jungle is shot out. They must also be as near subunit bases as possible to reduce travelling time.

TYPES OF RANGES

5. Although the first five stages can be practised on one combined range, troops will not have to wait so long for their turn to fire if each stage is kept separate, in which case they will be able to move on the next stage as soon as they have qualified on the previous one. For the same reason, several jungle lanes should be sited so that they can be used simultaneously.
6. Apart from a stand behind each firing point, where waiting details can prepare for and watch the practices, firing points should be kept in their natural state.
7. The range requirements for each stage are:
 - a. Zeroing and Grouping. A figure target imposed on a screen at least 1.3 m square, at 30 m range, for each firer.
 - b. Funfair. Brightly painted small targets, such as balloons, light bulbs, beer cans, bottles, and differently shaped wooden or metal discs, at ranges from 5 to 30 m. They should be at different heights over a wide arc and be able to be indicated by type or colour: on being hit they should break or fall.
 - c. Snap. Pull up or trench-operated snap figure targets, over a wide arc at ranges from 5 to 30 m.
 - d. Moving Target. Figure targets moving in trenches, or on sledges or overhead wires, across and diagonally, at ranges between 5 and 30 m.
 - e. Jungle Lane. A track should be prepared so that each firer followed by an instructor, advances along it and engages every target he sees. Apart from one or two running enemy, targets need not be activated, as they can be sited round bends, behind or up trees, so that they are come on suddenly. Quiet, fairly well concealed targets are the most realistic. By winding the track, targets can be made to appear at any angle, while remaining within a narrow arc, to avoid having to have exceptionally wide danger areas. Once proficiency has been attained, the track can be made more difficult to follow and a variety of incidents can be introduced.
 - f. Ambush. Apart from a trench, rail, or overhead cable on which figure targets can be moved through a killing area, and a clearly marked right and left of arc, the area of an ambush range should be left untouched. The targets should be made to follow a bend so that the position can be sited correctly in enfilade. Once the position has been occupied tactically, from an assembly area about 200 m to the rear, a safety officer must check that all weapons are sited to fire within the correct arc before the ambush is sprung.
 - g. Field Firing. An area containing different types of jungle, mock up villages and defensive positions, where live firing exercises can be carried out with and without support weapons.

TARGETS

8. Although electrically operated and pull up, targets can be used on jungle ranges; they are unnecessary except on the snap range, where a trench will also suffice. The less elaborate the target and its mechanism, the better. Figure targets can easily be made from pieces of packing cases, bark, cardboard, or tins painted to represent camouflaged enemy in likely fire positions. Enemy type uniforms and masks can also be stuffed to make realistic targets. They should have a plain sheet of paper or cardboard on the back to record hits, and all figure targets should have a 20 cm circle inscribed in the centre to define the higher scoring, vital target area.

METHOD OF FIRING

9. All firing of personal weapons including zeroing and grouping should be double tap; that is two quick aimed shots from the shoulder. Except on the ambush and field firing ranges, the firer should be standing with his weapon at the alert and return to it after each double tap. When cover is used, it must be natural jungle cover, fired round rather than over.

PRACTICES

10. The practices that follow represent the basic standard at which a firer must achieve a 50 per cent score before being allowed to progress to the next stage. They should be followed by realistic live firing exercises on ambush and field firing ranges and should be made more difficult as training progresses.

SUMMARY

11. Jungle ranges can be simple affairs and constructed amongst dense scrub within some barracks' perimeters. A conversion kit allows .22 rounds to be fired from the rifle which saves money and reduces the danger area dramatically.

RANGE PRACTICES

Practice	Range Metres	Target	Position	Rounds	Time Seconds	Scoring
1. Zeroing	30	Figure on screen	Standing	2 x 3	2 x 3	Nil. Practice repeated until MPI is central
2. Grouping	30	Figure on screen	Standing	2 x 3	1 x 3	20 points 10 cm Group 15 points 20 cm Group 10 points 30 cm Group
3. Funfair	5-30	Coloured	Standing	2 x 5	1 x 5	1 point per hit
4. Snap	5-30	Small Figure	Standing	2 x 5	1 x 5	2 points in vital area 1 point elsewhere
5. Moving Target	5-30	Moving Figure	Standing	2 x 5	2 x 5	2 points in vital area 1 point elsewhere
6. Jungle Lane	1-30	Figure	Walking	2 x 15	2 x 15	2 points in vital area 1 point elsewhere

ANNEX E

SUGGESTED SYLLABUS FOR JUNGLE WARFARE INSTRUCTORS COURSE

1. The following suggested syllabus is based on a six weeks' course. The instruction will, however, be intensive and the hours long and if more time is available, the course could usefully be extended. The programming allows for a 5 1/2 day week with an 8-hour day and up to 20 hours for evening and night work each week. Four hours have been allowed each week for revision and as spare periods to give the instructional staff some flexibility in arranging the program.

2. The total instructional time allowed for is 360 hours which with 24 hours spare makes a total of 384 hours (or 64 hours a week) broken down as follows:

- a. Indoor (lectures and films) 60 hours.
- b. Outdoor (demonstrations and practical work) 300 hours, and
- c. Spare 24 hours.

3. The allocation between main subjects is broken down as follows:

a.	Conduct of jungle Operations	- 30 hours
b.	Jungle craft	- 60 hours
c.	Movement Drills	- 50 hours
d.	Jungle Tactics	- 195 hours
e.	Weapons and Equipment	- 20 hours
f.	Course Administration	- <u>5 hours</u>
		360 hours
g.	Spare	- <u>24 hours</u>
	Total	- <u>384 hours</u>

4. A suggested detailed breakdown within subjects is as follows:

a.	<u>Conduct of Jungle Operations</u>		<u>Indoor</u>	<u>Outdoor</u>	<u>Total</u>
	Jungle Warfare Introduction	-	1	-	1
	Organization and Equipment	-	-	2	2
	Concept of Operations	-	2	-	2
	Psychological Warfare	-	1	-	1
	Security	-	1	-	1
	Intelligence	-	1	-	1
	Appreciations	-	2	10	12
	Operational Orders	-	<u>2</u>	<u>8</u>	<u>10</u>
	Totals	-	<u>10</u>	<u>20</u>	<u>30</u>

b. Jungle Craft

	Navigation	-	2	30	32
	Observation and Movement	-	1	1	2
	Camouflage and Concealment	-	1	1	2
	Tracking	-	1	2	3
	Survival	-	2	-	3
	Shelters	-	-	1	1
	Plants and Traps	-	2	2	4
	First Aid	-	2	2	4
	Health Precautions	-	1	-	1
	Escape and Evasion	-	1	6	7

Resistance to Interrogation	-	<u>2</u>	-	<u>2</u>
Totals	-	<u>15</u>	<u>45</u>	<u>60</u>

c. Movement drills

Silent Signals and Formations	-	1	1	2
Section Contact Drills	-	2	6	8
Platoon and Company Contact	-	1	6	7
Obstacle Crossing	-	2	8	10
Harbouring	-	2	14	16
Counter Transport Ambush	-	<u>2</u>	<u>5</u>	<u>7</u>
Totals	-	<u>10</u>	<u>40</u>	<u>50</u>

d. Jungle Tactics

Command and Control	-	1	-	1
Jungle Bases	-	2	1	3
Patrolling	-	2	8	10
Ambushing	-	2	8	10
Quick Attack	-	1	2	3
Deliberate Attack	-	1	2	3
Tunnel Clearance	-	-	2	2
Fire Support	-	1	-	1
Air Support	-	2	2	4
Casualty Evacuation	-	1	1	2
Exploitation	-	1	-	1
Cordon and Search	-	1	3	4

Dogs	-	-	1	1
Jungle exercises	-	-	<u>150</u>	<u>150</u>
Totals -		<u>15</u>	<u>180</u>	<u>195</u>

e. Weapons and Equipment

Familiarization	-	1	2	3
Fire Effect	-	-	1	1
Jungle Ranges	-	1	4	5
Warning Devices	-	1	2	3
Mines and Booby Traps	-	1	2	3
Night Lighting	-	-	1	1
Communications	-	<u>1</u>	<u>1</u>	<u>2</u>
Totals -		<u>5</u>	<u>15</u>	<u>20</u>

f. Course Administration

Opening Address				
Student Briefing				
Summing Up	-	5	-	5
Closing Address				
Drawing, Cleaning and Returning				
Weapons and Equipment	-	-	-	-
Totals -		<u>5</u>	-	<u>5</u>

ANNEX F

JUNGLE OPERATIONS AIDE-MÉMOIRE

This annex contains a check list of subjects which may be useful when making plans, composing orders, or arranging training for jungle operations at combat team level and below.

1. Situation

a. Intelligence

- (1) Maps, air photographs, sketches, and models.
2. Own, allied, police, and indigenous ground and air patrol, operational, reconnaissance, and intelligence reports.
- (3) Agents, informers, guides, and local knowledge.
- (4) Monitoring, locating, and surveillance devices,
- (5) Captured and surrendered enemy, supporters, documents, equipment, and interrogation reports.

b. Topography

- (1) General area of operations, present positions, target area, and connecting routes.
- (2) Permanent features; hills, ridges, rivers, lakes, and the sea.
- (3) Semipermanent features; town, villages, roads, railways, bridges, pipelines, and other construction.
- (4) The going; primary or secondary jungle, swamp, plantations, rice and other cultivation, clearings, and obstacles.
- (5) Bounds, boundaries, report lines, reference points, RVs, LPs, harbour areas. Codewords and nicknames.

c. Climate

- (1) Times of dawn, dusk and moonlight, and phase of the moon.
- (2) Prevailing and current rain, wind, cloud, mist, and temperature conditions.
- (3) Availability of water, state of tides, and flooding.

d. Enemy

- (1) Type and identification of units, individuals and sympathisers, history, recent background, morale, weapons, equipment, and dress.
- (2) Known and likely locations of defensive positions, bases, camps, hides, caches, supply and water points, LPs, DZs, RVs, assembly areas, courier, and escape routes.
- (3) Strengths, orbat, grouping, disposition, reconnaissance, escort, supply, and working patrols.
- (4) Types and scale of weapons and equipment, ammunition, mines, booby traps, and explosives, heavy or special weapons, air, armour, artillery, rocket, and mortar support CW capability,
- (5) Defences; strong points, bunkers, heavy weapons and machine-gun positions, fire trenches, sentries, tunnels, outposts, tree snipers, defensive fire (DF) targets, patrols, and ambushes.
- (6) Obstacles; vegetation, pits, water palisades, mines, wire, ditches, and booby traps.
- (7) Layout; HQ, radio, antennae, magazine, water points, latrines, accommodation, kitchens, messes, tracks, communication trenches, escape routes, tunnel exits, surrounding area, and covered approaches.
- (8) Routine and habits; sleeping, cooking, feeding, working, defecating, recreation, instruction, and indoctrination, sentries, patrols, and stand-to.
- (9) Times and method of movement, use of tracks or compass bearings, alertness, order of march, grouping, flank protection, tactical drills.
- (10) Use of dogs and local inhabitants.
- (11) Personalities; identification and characteristics of commanders, key personnel, specialists, radio operators, and system of escorts.
- (12) Intention, trends, pattern of activity, likely targets, areas of interest and intimidation, and direction of movement.
- (13) Communications; control, relay, security, codes, radio, hand, voice, whistle, bugle, flag, smoke, heliograph, light signs, runners, and couriers.
- (14) Logistic; sources, scales, duration, resupply, medical, health.
- (15) Transport; types, vehicles, pack animals, porters, boats, aircraft, method and times of movement, repair and recovery, fuel and fodder.

e. Local Population

- (1) Extent and system of local government and control.
- (2) Races and tribes, religion, customs, and languages.
- (3) Locations, distribution, and numbers.
- (4) Sympathies, affiliation, attitude, ability, health, resources and food situation.
- (5) Habits, recreation and movement, use of dogs and traps,
- (6) Participation in paramilitary organizations, police, militia, and guards.
- (7) Economy; employment, government, public services, factories, plantations, cultivation, transport, construction, mining, logging, and hunting.
- (8) Restrictions; curfews, passes, rations prohibited areas, special regulations,

f. Friendly Forces

- (1) Own and allied military, naval, air and police forces and dispositions, within the bounds of the need to know rule and any intended cover plan.
- (2) Type, locations, routes, boundaries, and identification.
- (3) Activity, movement, patrols, ambushes, ground and air operations, dogs, tasks, liaison, safety, and clearance.
- (4) Naval, air, artillery, and mortar DFs, and fire support.
- (5) Minefields, defences, booby traps, and obstacles.
- (6) Reserves and quick reaction forces, assistance available and casualty evacuation.
- (7) Special forces or agents with the enemy or local people.
- (8) Guerilla forces.

g. Attachments

- (1) Trackers, scouts, guides, informers, captured or surrendered enemy, porters, boatmen, and enterpreters.
- (2) Dogs, pack animals, and handlers.

(3) Own or allied arms, police and service elements, including FACs, FOOs, and naval gunfire support forward observers (NGSFOs).

(4) Liaison, contacts, RVs, and reporting times.

h. Detachments

2. Mission

3. Execution

a. General Outline

b. Patrol Insertion

(1) Cover plan and deception.

(2) Method; airland, parachute, helicopter, boat, rail, vehicles, pack animals, foot, civil, or military.

(3) Marrying up times and RVs.

(4) Grouping, command, communications, and loads.

(5) Route, order of march, bounds, RVs, pickets and timings (formation, bearing, and distances for foot moves).

(6) Speed, spacing, halts, and protection from ground and air.

(7) Debusing, DZ, deplaning, disembarking or beaching drills, concealment of signs of entry, and disposal of boats or parachutes.

(8) Counter ambush, contact, obstacles, halt, lost, and casualty drills.

(9) Recovery and casualty evacuation.

(10) Fire support.

c. Establishment and Defence of Bases

(1) Probable location and type, RV, or harbour.

(2) Dryness, slope, water access, suitability for radio communications, concealment, defence ambush, and withdrawal plans.

- (3) Immediate ambush rear, reconnaissance, and occupation.
- (4) Stand-to, clearing patrols, camouflage and concealment, sentries and alert drills.
- (5) Outposts, warning devices, mines, tripflares, and booby traps.
- (6) Defences, fire positions, fields of fire, obstacles, and DF tasks.
- (7) Water points, latrines, and refuse pits.
- (8) Control; signals for stand-to, stand-down, open and cease fire, noisy, silent or emergency withdrawal to specified RV.
- (9) Routine; sitreps, day and night sentry roster, stand-to, cleaning weapons, cooking, smoking, washing, lights, noise, medical attention, and erection of shelter sheets.
- (10) Removal of traces of occupation before departure.

d. Patrol, Search of Close Reconnaissance

- (1) Grouping, composition, tasks.
- (2) Command, communications, radio silence, silent hand signals.
- (3) Start points, objectives, bearings, distances, bounds, boundaries, and RVs,
- (4) Time out and anticipated time of return.
- (5) Order of march, formation, spacing, dogs, trackers, guides, signallers, medical orderlies, engineers, FAC, FOO, NGFSO, Fire controller (FC), and other specialists or attachments.
- (6) Security; avoidance of tracks, defiles, obvious routes, cutting, noise, talking, smells, smoking, cooking, leaving, sign, bunching, single file in open areas, and returning by same route.
- (7) Contact, obstacle, halt, lost, and casualty drills.
- (8) Fire support.

e. Ambush or Encirclement

- (1) Composition, grouping, and tasks.
- (2) Killing areas, type, and duration of ambushes.
- (3) Command and communications.

- (4) Assembly areas and approach routes.
- (5) Reconnaissance.
- (6) Warning arrangements and alert drills.
- (7) Method, sequence, and timing of occupation.
- (8) Fixed lines, arcs of fire, mines, claymores, flares, lighting and warning devices, responsibility for setting up and initiation, camouflage, and concealment.
- (9) Rest, administration or reserve areas, location, command, communications, all round defence, state of alertness, sentries, stand to, feeding, cooking, sleeping, latrines, system of reliefs, counter attack and withdrawal role, camouflage and concealment.
- (10) Clear signals and order for springing, cease fire, call off, attack, search, follow up and withdrawal.
- (11) Action on compromise or call off.
- (12) Fire support.

f. Attack

- (1) Composition, grouping, command, and communications.
- (2) Phases, objectives and timings, including H-hour (not before..... hrs).
- (3) Assembly area, FUP, bearing to objective, SL, formation, axis, and limit of assault.
- (4) Breaching place and position of fire groups.
- (5) Composition and method of search and mopping up.
- (6) Reorganization; location and arcs of fire.
- (7) Fire plan and direct fire support.

g. Exploitation

- (1) Composition, grouping, and location of follow up and reaction forces, including dogs and trackers.
- (2) Standby readiness, transportation, tasks, and limit of exploitation.

(3) Command and communication, fire support, and logistics.

h. Extraction

(1) Method, extraction point, type of transport, and fire plan.

(2) Order of march, routes, bounds, and delaying action.

(3) Security and defence of extraction point.

(4) Action on return.

(a) Clean weapons,

(b) Urgent medical attention.

(c) Debrief and interim report.

(d) Clean, check, account for, replace or repair and repack weapons, equipment, supplies, ammunition, rations, and cash.

(e) Mail, food, rest, medical and dental checks, recreation, and welfare stores.

(f) Lessons learnt, full operational report, train on weak points, prepare for next operation.

j. General Coordination

(1) Timings.

(2) Preparation, zeroing, checking, testing, and inspecting weapons and equipment.

(3) Cover and deception plans and rehearsals.

(4) Support; DF, artillery, mortars, rockets, small arms, armour, naval gunfire, air strike, bombing, armed helicopters, high explosive (HE), armour piercing (AP), smoke, incendiary, close support (CS), and illuminating.

(5) Action on being ambushed, captured, or compromised.

(6) Action on contact (seen or unseen) with enemy, civilians, friendly forces or dogs, or on finding enemy positions, defences, camps, caches, tracks, sign, weapons, equipment, mines, or booby traps.

(7) Obstacle crossing drills for rivers, roads, open ground, cliffs, swamps, and bamboo.

(8) Procedures for dealing with casualties, captured enemy, weapons, or equipment.

(9) Safety, identification, clearance, liaison, RVs, boundaries, and report lines.

4. Logistics and Ammunition

a. Weapons and Ammunition

(1) Types and distribution.

(2) Special and lightweight weapons (flame throwers, if available) rockets, grenade launchers, mortars, shotguns, and silent weapons.

(3) Incendiary, tracer, AP, ball, signal and illuminating rounds, empty magazines and limited numbers in magazines.

(4) Explosives, primers, detonating cord, detonators, fuses, phosphorous, signal, and CS grenades.

(5) Explosives, primers, detonating cord, detonators, fuses, firing devices, batteries, cable junction and switch boxes, tape, pliers, and knives.

(6) Weapon cleaning and spare parts kits, oil, and material.

b. Rations

(1) Type, weight, hot or cold, amount in days.

(2) Dog, pack, animal and tracker rations.

(3) Rum, slat and vitamin, and anti-malaria tablets.

(4) Non-smelling fuel.

(5) Minimum packing to reduce litter, noise, and weight.

c. Water

(1) Availability.

(2) Number of water bottles per man.

(3) Sterilizing tablets, millbank bags, and lemonade powder.

d. Money

(1) Clothing (smeared with insecticide) and footwear.

- (2) Identification.
- (3) No documents, marked maps, letters, or photographs.

f. Basic Equipment

- (1) On body; weapon, compass, watch, lighter, clasp knife, flashlight, batteries, escape and survival kit, medical kit, shelter sheet, ID discs, nylon cord, spoon, whistle, comb, mirror, notebook, and pencil. No rattles.
- (2) On the belt; ammunition, water bottles, millbank bag, jungle knife, and emergency rations.
- (3) In packs; sweater, socks, cooking pot, water bag, toilet kit, radio, beacon, green nylon rope, miniflares, air panels, marker balloons, binoculars, digging tools, saws, wire cutters, insect repellent, miticide, lighter fuel, rifle oil, and optional items.

g. Special Equipment

- (1) Type, distribution, and responsibility for setting up and operating.
- (2) Air photographs.
- (3) Cameras, film and fingerprint kit.
- (4) Warning and surveillance devices.
- (5) Cable or cord for silent communication.
- (6) Night lighting equipment,
- (7) Floats and flippers for river crossings.
- (8) Climbing irons, telescopic sights, sling, and camouflage net for tree snipers.
- (9) Hammocks for swamp or flooded areas.
- (10) Pace counters.
- (11) Surrender leaflets.
- (12) Defence stores.

h. Medical

- (1) Casualty equipment and evacuation procedure (air panels for stretcher).
- (2) Patrol medical orderlies.
- (3) Medical or dental unfit.
- (4) Patrol and individual medical packs, morphia, and shell dressings.
- (5) Anti-malaria tablets, sterilizing tablets, salt, and vitamin pills.
- (6) Insecticide, insect repellent, and foot powder.

j. Resupply

- (1) Caches, supply points, LPs, and DZs.
- (2) Pack animals, porters, and boats.
- (3) Cash or living off the land.

k. Transport

- (1) Aircraft, helicopters, boats, vehicles, pack animals, porters, or local transport,
- (2) Reporting times, RVs, and start point (SP).
- (3) Command and control.
- (4) Loads, grouping, and order of march.
- (5) Routes, bounds, pickets, and timings.
- (6) Vehicle commanders, air and ground sentries, radio and visual communications.
- (7) Speed, spacing, halts and protection from ground and air.
- (8) Counter ambush, contact, obstacle, halt and lost drills, and
- (9) Repair and recovery.

5. Command and Signal

a. Command

- (1) Position of commander.

- (2) Commanders of groups.
- (3) Alternative commanders.
- (4) Command roster at night.

b. Radio

- (1) Allocation of sets, batteries, hand generators, and operators.
- (2) Net diagram call signs and frequencies for flanking units, ground, naval and air support, administration, and emergencies.
- (3) Antenna lengths and directions, use of CW key or larynx microphones.
- (4) Schedules and alternative frequencies.
- (5) Special instructions; radio silence, listening watch, relay rebroadcast, waterproofing of sets and of batteries.
- (6) Time to test communications.
- (7) Communication failure drill.
- (8) Reporting pro forma; Situation Report (SITREP), Mortar Firing Report (MORTREP), Shelling Report (SHELREP), Bombing Report (BOMBREP), CASEVAC, and demands for resupply or maintenance.

c. Codes

- (1) Current codes.
- (2) Codewords, nicknames, and passwords.
- (3) net identification sign (N I S), address groups, and authentication.

d. Ground/Air

- (1) DZ, LP and target identification, codes and signals.
- (2) Signal panels, flares, lights, smoke and marker balloons.

e. Ground Signals

- (1) Signal for freeze, warning, and stand to.

- (2) Silent and/or noisy or visual for identification, open and cease fire, stand down, command detonation, attack, search, follow up, withdraw, disperse, success and reorganization.
- f. Testing. All equipment, including spare batteries,
- g. Confirmation. Questions. Synchronization of watches.

B-GL-302-004/FP-002
(FORMERLY B-GL-302-004/PT-002)

SPECIFIC OPERATIONS

VOLUME 4

PART TWO

A SOLDIER'S GUIDE TO THE JUNGLE

STOCK REPRINT: All changes incorporated up to and including
change 1 dated 1983-02-02

THIS PUBLICATION CONTAINS CLASSIFIED
INFORMATION AFFECTING THE DEFENCE OF CANADA,
AND SHALL BE PROTECTED IN ACCORDANCE WITH THE
REGULATIONS PRESCRIBED FOR THE SECURITY
CLASSIFICATION APPEARING HEREON. RELEASE OF THIS
PUBLICATION, OR INFORMATION CONTAINED HEREIN,
TO ANY PERSON NOT AUTHORIZED TO RECEIVE IT, IS
PROHIBITED BY THE OFFICIAL SECRETS ACT.

OPI: FMC HQ

77-03-18
Ch 1 - 1983-02-02

ISSUED ON AUTHORITY OF THE CHIEF OF THE DEFENCE STAFF

FOREWORD

1. B-GL-302-004/PT-002, Specific Operations, Volume 4, Part Two, A Soldier's Guide to the Jungle, is issued on authority of the Chief of the Defence Staff.
2. It is effective on receipt and should be read in conjunction with B-OG-302-004/FP-001, Specific Operations, Vol 4, Jungle Operations, Part One, Tactics.
3. Any loss of suspected compromise of this publication, or portions thereof, shall be reported in accordance with A-SJ-100-001/AS-000, Chap 60.
4. Suggestions for changes to this publication shall be forwarded through normal channels to Mobile Command Headquarters, Attention Senior Staff Officer (SSO) Doctrine.

TABLE OF CONTENTS

CHAPTER 1 - INTRODUCTION

General
Aim
Scope
The Right Attitude
Description of the Jungle
The Enemy

CHAPTER 2 - JUNGLE CRAFT

Section 1 - Living in the Jungle

General
Water
Plant Food
Animal Food
Light Weight Jungle Rations
Cooking
Shelter

Section 2 - Concealment and Observation

Concealment
Observation

Section 3 - Communicating In the Jungle

General
Radio Operating
Line Operation
Other Means of Personal Communication

CHAPTER 3 - NAVIGATION AND TRACKING

Section 1 - Navigation

General
Limits in the Jungle
Lost Drill

Section 2 - Tracking

General
Tracking Sign
Deception
Tracking Drill

CHAPTER 4 - JUNGLE MOVEMENT

Section 1 - Movement

On the Move
At the Halt
In Transport
Lost Drill

CHAPTER 5 - HEALTH

Section 1 - Personal Protection

Basic Essentials
Mosquito Borne Diseases
Scrub Typhus
Bowel Disease
Heat Illness
Skin Disease

Section 2 - Field Treatment

General
Medical Packs
Treatment
Snake Bite

Section 3 - Casualty Evacuation

Aim
Considerations
Evacuation Priorities
Recovering Priorities
Recovering Battle Casualties
Helicopter Evacuation
Other Means of Evacuation

ANNEXES

- A SILENT HAND SIGNALS
- B AIDS TO CROSSING WATER OBSTACLES
- C SUGGESTED LOADS - INDIVIDUAL SURVIVAL KIT

LIST OF FIGURES

FIGURE TITLE

- 2-1 The Fiddle Fern (inset - a young frond which is edible)
- 2-2 Wild Ginger
- 2-3 Tapioca
- 2-4 Fish Trap
- 2-5 Bird Trap
- 2-6 Monkey Trap
- 2-7 Small Animal Trap
- 2-8 Pig Trap
- 2-9 Pig Trap-Detail
- 2-10 Small Animal Trap - Double Noose
- 2-11 Large Animal Trap Type A
- 2-12 large Animal Trap Type B
- 2-13 Large Animal Trap Type B - Detail
- 2-14 Large Animal Trap Type C
- 2-15 Large Animal Trap Type C - Detail
- 2-16 Simple Jungle Shelter
- 2-17 Alternative Jungle Shelter
- 2-18 Non-Tactical Shelter
- B-1 First Step
- B-2 Second Step
- B-3 Third Step
- B-4 Fourth Step
- B-5 Leaving the Water With a Float Made From a Waterproof Sheet Wrapped Around
Personal Equipment
- B-6 Individual Flotation Trouser Method
- B-7 Taking a Line Across a Water Obstacle
- B-8 Crossing a Water Obstacle - Pendulum Method
- B-9 Crossing a Jungle River Assisted by a Rope
- B-10 Method of Tightening a Rope

LIST OF TABLES

TABLES TITLE

2-1	Suggested Light Weight Jungle Ration
5-1	Suggested Contents of Individual Medical Pack
5-2	Suggested Contents of Section Medical Pack
A-1	Silent Hand Signals
C-1	Suggested Items for Inclusion in Individual Survival Kit

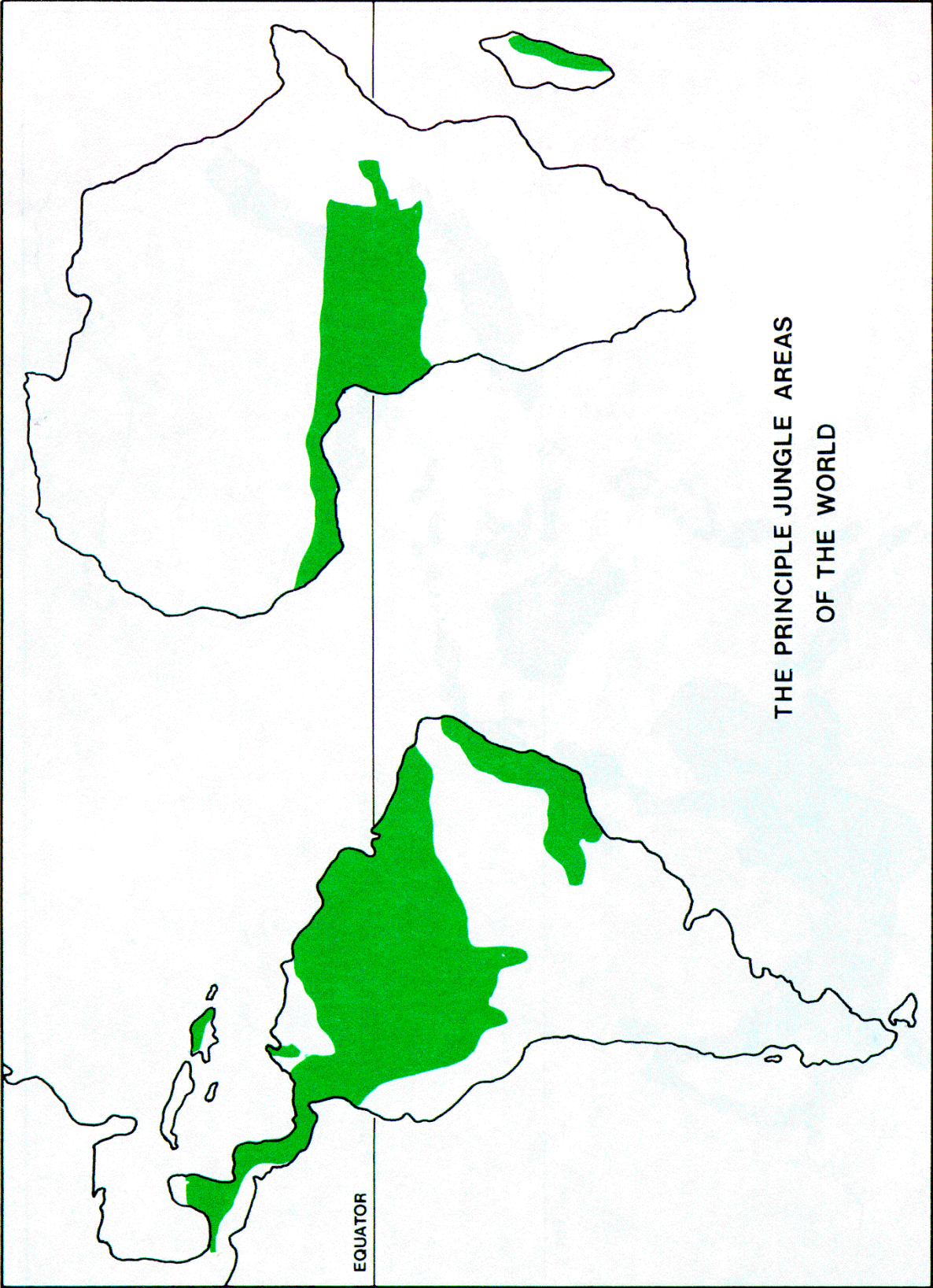

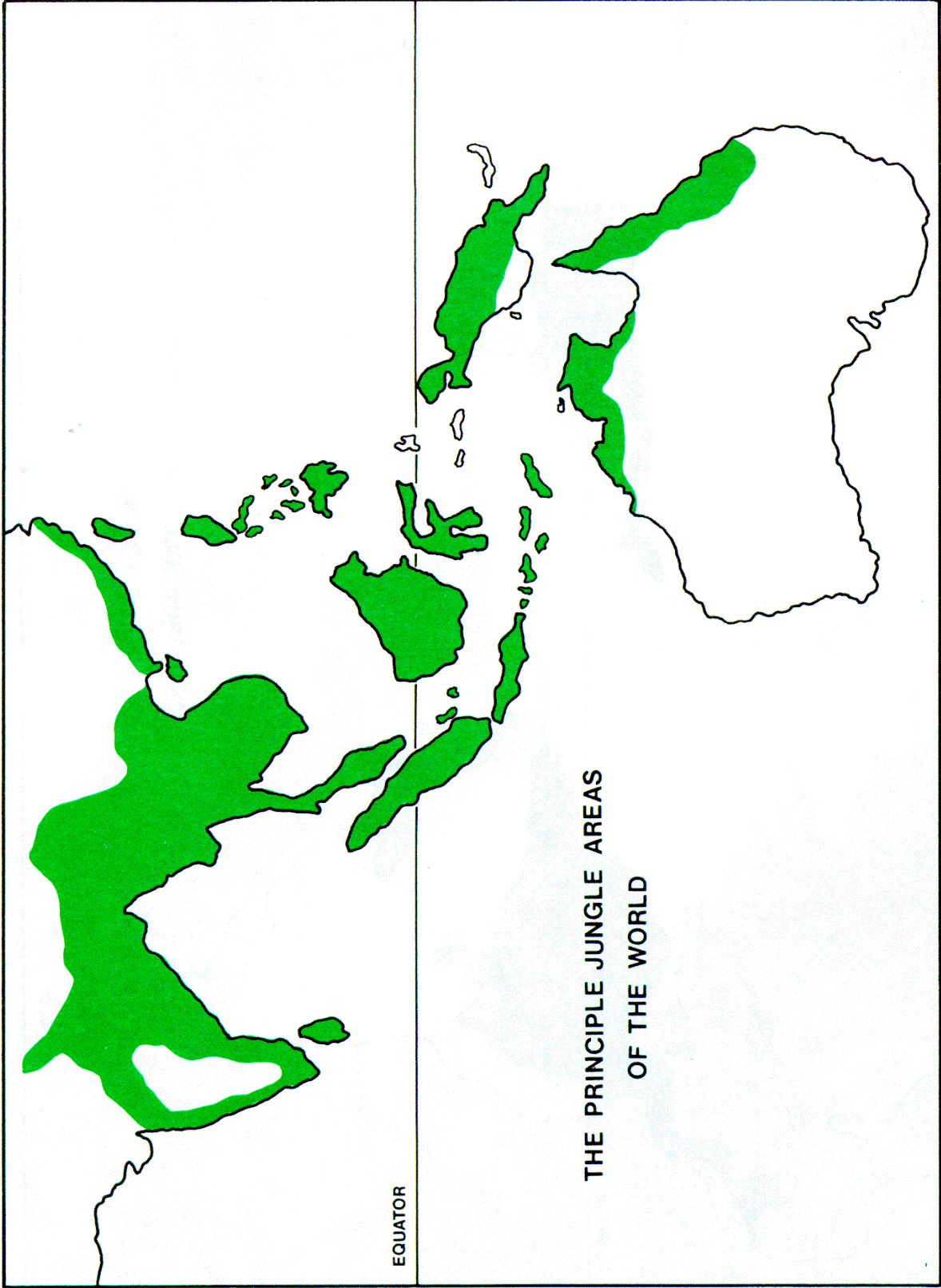

EQUATOR

THE PRINCIPLE JUNGLE AREAS
OF THE WORLD

CHAPTER 1

INTRODUCTION

General

1. As a member of the Canadian Forces, you must be prepared to live and fight in the jungle. CFP 302(4), Part One provided a guide for commanders from formation to section level. This part provides skill and drills which will be of use to all ranks, as individuals.

Aim

2. The aim of this publication is to give information concerning the jungle so that you may be able to operate effectively.

Scope

3. This publication will cover description, the enemy, jungle craft, health, and training as applied to jungle terrain. Emphasis will be placed on details. Although all weapons, equipment, and methods described herein may now not be part of the Canadian Forces inventory, it is certain that jungle operations will see their adoption by Canada or at the very least, our operating with forces which do possess them.

4. The description of the jungle and the enemy are condensed from those given in Part One. All ranks should read at least Chaps 2 and 3 of Part One for more detailed information.

The Right Attitude

5. Living and fighting in the jungle is largely a matter of being fit, having the right equipment, and remembering your training. One of the most important pieces of equipment you can carry is a good attitude.

6. The jungle is different - but then so is winter to someone who has not seen it before. Before being committed to jungle operations you will be well trained. Rely on this knowledge and use it to comfort you. Do not fear the jungle; use it as an ally. If you have a proper attitude, the problems of jungle living are well on their way to being solved.

Description of the Jungle

7. The frontispiece illustrations show the principle jungle areas of the world. Jungle terrain occupies almost one-third of the earth's tropical zone and is composed of areas of high temperature and humidity where the natural vegetation is largely rain forest. Included also are deciduous forest, swamp, and tropical grasslands. Jungle is found in South East Asia, Africa, Latin America, and Australia.

8. The more important characteristics of jungle areas are climate, terrain, communications, and disease:

a. Climate - The climate will have a direct effect on your equipment and your methods of operating. In Canada, we sense the changing of the seasons by temperature changes; in the jungle, the seasons are identified more by the direction of the winds and the amount of rainfall;

b. Terrain - The main types are -

- (1) rain forest or primary jungle - This is normally referred to as jungle and has a thick overhead canopy up to 65 metres high. As the sun has a hard time penetrating this canopy, the ground level is often dark and gloomy, damp, and dripping with moisture,
- (2) secondary jungle - This occurs where the jungle has been cleared and allowed to grow again. It is thicker than primary
- (3) swamp These vary from the very dense and difficult to the easily passable. Swamp areas are unhealthy,
- (4) grasslands or savannah - These are areas of coarse, sharp-edged, and very dense grass. Heat is trapped and the temperature and humidity are much above that of the overhead air,
- (5) cultivated areas These are in two groups rice fields and plantations. Rice fields are covered by water from five to ten months of a year. On plantations, trees are planted in regular lines up to 10 metres apart;

All these terrain types are very hard on movement and visibility.

c. Communications - Roads and railways are limited, if available at all. Bridges are not usually wide enough or strong enough to accept military loads. Water transport is used extensively. Airfields are limited both in number and size. Radio noise is high, range is limited, and radio relay stations can probably only be placed by air this discloses their locations;

d. Disease You must be extremely careful in the use of local food and water. Disease is very common in the tropics, protective measures must be practised constantly, and a high priority must be given to health discipline. The operational efficiency of your unit will depend to a large degree on your being fit to fight.

The Enemy

9. He may be either a regular soldier or a regional soldier. He normally uses Soviet or Chinese types of weapons and equipment and draws his inspiration from political officers attached to his unit. He is deeply influenced by this political doctrine and is likely to be fanatically dedicated to his cause.

10. The regular soldier is usually a conscript. He has a uniform and has received a thorough training in infantry matters - even if he is not one of the chosen few. His strong points include being:

- a. Expert at fieldcraft and forced marches with heavy loads;
- b. Able to ambush well;
- c. A good digger;
- d. Brave, determined, and fanatical; and
- e. Able to exist on low rations for long periods of time without having his morale affected.

However, he is only a man and has weak points. He is slow to react to new ideas and situations, his skill at arms is not what it should be. Being heavily dependent on the local population for intelligence, food, shelter, supplies, and labour is also a disadvantage.

11. The regional soldier devotes only part of his time to military matters. He serves close to home. His only uniform is a cap or arm band and he may not have his own weapon. He is likely to be good at ambush and sabotage.

12. The particular tactics practised by the enemy concern us less than the fact that he understands the jungle and uses it to his advantage. To defeat him, we must train well and hard; use the jungle as an ally and always be ready for the unexpected.

CHAPTER 2

JUNGLE CRAFT

SECTION 1 - LIVING IN THE JUNGLE

General

1. In the jungle, most fighting will be between small groups or patrols. The side which can detect the enemy without being detected, move silently, and shoot quickly and accurately will most likely win. As the enemy will surely be well trained in these matters, you must strive to be better.
2. You can survive in the jungle - if you are acclimatized, know how to obtain food, water, and shelter, and know how to remain healthy. Physical and mental fitness are most important. You will have to learn to become accustomed to being permanently wet and to living in dark, dreary surroundings.

Water

3. You will find that during acclimatization you will need up to 12 pints of water per day. Also a salt tablet will be essential. After you have sterilized the water, do not dissolve or crush the salt tablet. Swallow it whole.
4. If there are no streams or rivers - do not panic! Water may be obtained in a number of other ways. Do not forget that it takes time to collect water and that those who do the collecting must have their own water for the journey to and from the source.
5. The following will help you in your search from thirst:
 - a. Collect rain water;
 - b. Dig for it, or drive a long pole into the ground in a depression, the hole will usually fill with water;
 - c. Cut unjointed lengths of thick Jungle vine as high up and as low down as possible, fresh water will drain out. Do not touch the vine with your mouth - it will cause a rash,
 - d. Collect water from plants - especially palms, bamboo, and coconuts -
 - (1) palms - To start the fluid of a palm growing, cut off the tip of the flower stalk after bending it downward. If you cut off a thin slice every 12 hours, you can renew the flow and collect up to a quart a day,

- (2) coconut - Select green coconuts. You can open them easily and they have more milk than ripe coconuts. Do not drink more than three or four cups of ripe coconut Juice a day, because the juice acts as a violent laxative,
 - (3) bamboo stems often have water in the hollow Joints. Shake the stems of old, yellowish bamboo. If you hear a gurgling, cut a notch at the base of each Joint and catch the water In a container;
 - e. You can also make a still. Dig a hole 1-1/2 metres across by 1 metre deep and cover it with a sheet of waterproof material weighted at the centre. Put a can under the centre to catch the water which will form. This method will work best in damp ground and direct sunlight.
6. Except for fresh rain-water and that which you collect from vines or coconuts, all water must be filtered and purified before drinking. It should be filtered through a millbank bag and have one fresh sterilizing tablet shaken up in every litre and then allowed to stand for at least 30 minutes before you drink it. If you don't have a millbank bag, filter the water through a sand-filled cloth and then boll it for at least five minutes.

Plant Food

7. Jungle food should only be used in an emergency since living off the land is almost a full time job. Carry salt with you as it is very difficult to get in the jungle.
8. Precautions - Many plants are safe to eat; many are not. Just because birds and animals eat certain plants does not mean that they are safe for you:
- a. As a general rule, red fruit and plants with white sap should be avoided, and the taste test applied to the part of any plant which is being considered as food unless it is definitely identified as edible. The taste test consists of the following stages -
 - (1) touch the proposed food with the tongue,
 - (2) break off a pea-sized portion, chew it, and spit it out,
 - (3) wait five minutes, then chew and swallow a pea-sized piece,
 - (4) wait 20 minutes, then chew and swallow about 2 cubic inches,
 - (5) wait about half an hour before eating a reasonable amount,
 - b. If it tastes very bitter or causes any unpleasant reaction at any stage of the test, it should be discarded and the mouth washed out, or if it has been swallowed it should be regurgitated,

c. This test can be repeated after cooking, as some parts of plants which are poisonous when raw are edible when cooked or Filter boiling a number of times in changes of water. Samples of plants which have been tested should be kept for future reference.

9. Collection - In primary jungle, the height of most of the trees makes it extremely difficult to collect fruit and leaves, while the lack of sunlight on the ground does not encourage the growth of smaller plants. The majority of edible plants are more likely to be found in clearings and alongside tracks or streams and rivers, where the sun has been able to penetrate the canopy. Descriptions of the more common and easily identified plants fit for food are listed below.

10. Edible Wild Plant Foods:

a. The young shoots and apical buds of all palms and bamboos can be eaten raw, though the more bitter varieties taste better cooked. The outer layers must be peeled off, until the crisp and edible interior is reached. Care must be taken to avoid the fine irritant hairs or sharp needle spikes which are often present;

b. Larger palms such as the Nibong, Sago, and Coconut will usually have to be felled to obtain the apical bud, which is often about 3 feet long and will yield several pounds of good food, whereas the smaller palms may only produce a few ounces. Apart from the coconut the fruit are not usually edible, but sago can be extracted from the pith of the sago palm by crushing it under water. It can be cooked as a porridge or dried to use as flour;

c. Ferns The characteristic curly or fiddle-shaped young fronds of ferns can be eaten raw, though they are much more palatable cooked, and delicious fried (see Figure 2-1). Any fine hairs should be rubbed or singed off. They are edible as far down the stem as it can be snapped cleanly between finger and thumb, or in the case of Bleecham, which is a more open-leafed fern, as far down the stem as is red;

d. Pit - Resembling thin, reedy, sugar cane, pit grows to a height of 3 metres and has a reddish-green stem covered in green leaves, one to one and one-fifth metres long and about 10 cm wide. The leaves turn yellow on older plants. It is found on the banks of creeks and rivers, and the tender young shoots can be baked in hot coals or boiled, after which the leaves should be removed to reveal what is sometimes described as " Jungle Asparagus" ;



Figure 2-1 The Fiddle Fern - (Inset - a young frond which is edible)



Figure 2-2 Wild Ginger

- e. Wild Ginger - Broad bamboo-shaped leaves grow in pairs out of smooth finger thick stems, which are found in clumps up to 3 metres high (see Figure 2-2). Except for the young leaves and shoots, which are red and can be eaten raw or cooked, the plant is a very deep green;
- f. Dog Right - A pale green creeper with curly tendrils and an angled stem, covered in short brown hairs. The single large heart-shaped leaves are pointed and have five or seven veins radiating from the stem and rejoining at the point. The young shoots can be eaten raw or cooked;
- g. Wild Rhubarb - This plant bears no resemblance to cultivated rhubarb. It has a reddish twiggy stem, with pointed oval leaves and straight green shoots. The latter and the young leaves have a pleasant lemon flavour if they are eaten raw;
- h. Cassenda or Onion Tree - The tender leaves of this tree can be eaten raw or cooked, and the bark may be used as flavouring. It is distinguished by its strong garlic smell;
- j. Acacia - A tree which grows to a height of about 6 metres and has laburnum-type leaves and a red flower, which produces a seed pod. The young curly leaves and the seeds may be eaten raw or cooked;
- k. Pandanus - Found near water, frequently on the coastline but also up to 3,500 metres, the pandanus has long, narrow leaves with a saw edge and midrib. The trunk is covered with sharp spikes and the fruit grows in large, red, segmented ovals with a rough surface. When ripe, they break open revealing closely packed, small, oval, grey, seed containers. The oily juice which can be sucked from the ripe seed is nutritious and has a rich 'Winey' smell. A machete or stone may be necessary to extract the seed after the grey containers have been dried in the sun;
- m. Coco Yam or Taro - Growing up to 1.3 metres high, the flower is like a greenish arum lily and is surrounded by a cluster of light green stems, each of which terminates in one large, dark green, heart-shaped leaf. There is often a blue or purple spot where the stem joins the middle of the leaf. The root should be well cooked, peeled, and taste tested before being eaten, as some similar plants are poisonous. The young leaves can also be boiled as " Greens" ;
- n. Lilies - The fleshy roots, seeds, and stems of water lilies are edible raw or cooked. Stems should be peeled and eaten like celery, whereas the seeds can be pounded into a dough and roasted. When burnt, the leaves produce an ash which can be used as seasoning;
- p. Fungi - Most of the softer fungi, found growing on wood, are edible raw, but they are difficult to identify and their food value is small;
- q. Seaweed - Young, brightly-coloured seaweed is the most palatable, though all varieties are edible raw. They are not particularly salty in flavour and have a considerable fresh water content.

11. Cultivated Plants:

a. Those that are most commonly found growing wild are -

(1) banana and plantain,

(2) pawpaw or papaya,

(3) jak and bread fruit,

(4) mango, guava, passion fruit, durian, and wild raspberry,

(5) sugar cane and maize,

(6) yam, sweet potato, and tapioca, and

(7) coconut palms and rubber trees;

b. They are best identified by visiting local fruit and vegetable markets and cultivated areas. Those which are normally eaten raw may taste better cooked if they are not ripe;

c. In some instances, parts which are not normally eaten may also be edible, such as the trunk and bud of the banana, apical bud of the coconut, calyx of passion fruit, nuts from rubber trees, and leaves of tapioca;

d. Tapioca bears special mention as it grows wild readily and is also often planted by indigenous tribes. Also known as cassava or manioc, it grows to a height of 3 metres and has leaves like a lupin (see Figure 2-3). The large tuberous roots are edible and grow up to .6 metres long. There are two basic types, sweet and bitter. The sweet have red veins on the leaves and stems. They should be well cooked in a similar manner to potatoes. Before being cooked, the bitter varieties, which can be distinguished by their white veins, should be grated into a cloth and squeezed under water to wash out the high acid content.



Figure 2-3 Tapioca

12. Poisonous Wild Plants:

a. The following in particular should be avoided -

- (1) the Milky Mangrove - A small shrub which only grows in mangrove swamps and is distinguished by its white milky sap. Everything about it is an irritant, even the smoke if it is burnt. The milky Juice which easily spurts out, causes violent blistering and blindness if it gets into the eyes,
- (2) the Nettle Tree - The small trees have large, velvety leaves which are heart-shaped and saw-edged. The many small flowers are green or green and white and the clusters of berries look like black berries. They are especially common near water and produce a burning sensation when touched. If a large area of skin is affected, a high fever and intense pain can last for several days. A solution of carbonate of soda or wood ash will help reduce the irritation,

- (3) Cowhage or Cowitch - A climbing plant with oval leaves found in scrub but generally absent from true forest. The flowers and pods are covered with stiff hairs which readily break off and penetrate the skin. They are very dangerous if they get into causing considerable irritation. They are very dangerous if they get into the eyes. The flowers vary from greenish white to red or dark purple.
- (4) Rengas - There are several kinds of tall forest trees known Jointly as Rengas. The bark, timber, or water off the tree cause a localized rash. They have long, spear leaves and clusters of small five-pointed starlike flowers.

Animal Food

13. The easiest forms of animal food to obtain in the jungle area are insects, and fish, as most other animals and birds have learnt to fear man and use their acute senses to maintain a safe distance and are very rarely seen and are extremely difficult to catch or trap.
14. Slugs and Snails - These are very easy to obtain and can be found in small hollows and in colonies on edible plants and should be boiled in several changes of water until no scum occurs.
15. Other Insects - Large grubs are easy to find in rotten logs. They should be split and broiled over a fire, as should caterpillars, after singeing to remove irritant hairs. Grasshoppers and similar insects can also be roasted after their wings and legs have been removed.
16. Reptiles - Tortoises and turtles are particularly easy to catch, while all reptiles are good eating. Frogs can be caught with a net or by hand and can be dazzled by using a torch at night; they will also take a baited hook. Snakes are frequently found in water and under logs and rocks. One sharp blow with a stick on the top half of their back will kill them, although they will continue to wriggle for some time. Large monitor lizards provide a lot of meat and are harmless, though they put on an aggressive act. They can be run down and grabbed by the neck and tail. The position of tree lizards low down on tree trunks should be carefully noted and the tree approached from the opposite side, when the lizard can be grabbed unawares. None of the Asian lizards are poisonous and as they have no teeth, their bite rarely draws blood.
17. Fish - Jungle streams normally abound with edible fish, eels, fresh water prawns, crayfish, and crabs. The only poisonous fish are some of the highly-coloured or spiney salt water varieties, which should be avoided. Fish may be caught by any of the following methods:
 - a. Nets can be woven from string, vines, and creepers or improvised from face veils, mosquito nets, or hammocks. They should be threaded onto a suitably bent stick or fixed over a gap in a dam made of stones, leaves, and twigs, and the fish driven into it;
 - b. Scoops can be made of thin twigs woven together and mounted on a frame or thick bamboo stem split finely down to one segment, to use as a handle, and splayed out, with creeper or vine woven in and out of the ribs;

- c. Traps made as shown in Figure 2-4 should be baited so that the fish cannot get at it from the outside, and securely anchored in a gap left in a dam, where the water flows slowest. Traps should be inspected at least once a day;
- d. Hook and line: both can be improvised, hooks being made from pins and pieces of metal or carved from bamboo. Lines can be made from rattan, vine, or threads drawn from clothing and plaited for strength. Food, insects, or berries can be used as bait or a lure made from cloth, paper, or metal. Crabs, frogs, eels, turtles, and even snakes will also take a suitably baited hook;
- e. Spears or gaffs can be made from bamboo. The points of the prongs should be barbed and hardened in a fire;
- f. Poisoning: the bark and twigs of the matchbox bean, a vine producing flat woody pods up to 1 metre long, or the roots of the tuba, which spread over wide areas on and just below ground level, should be pounded with a stone to release the sap and dipped frequently into a slow running stream. Small fish die within about 10 minutes, while larger ones become stupefied and can be scooped out with ease. Traps or nets should be set 50 metres or so downstream to collect the dead and stunned fish, which are perfectly safe to eat. Tuba can be recognized by the fact that its oval leaves grow close together on green shoots, growing at an angle to the brown creeping stem;
- g. Failing all other methods, fish can be chased into the shallows and caught by hand, or left high and dry in tidal waters.

18. Birds and Animals - The most likely to be met are wild pig, monkeys, squirrel, deer, civet cats, bats, and birds. Despite their natural instinct for survival, the traps illustrated in Figures 2-5 to 2-15 of this chap can be set to catch some of them or attempts can be made to shoot them with bows and arrows made from bamboo, if the use of fire-arms is likely to attract unwelcome attention:

- a. To have the best chance of trapping, it is necessary to identify tracks, which can be learnt by a visit to a local zoo, so that the right type and size of trap can be placed in runs or on the approaches to water holes, feeding grounds, or salt licks. Several traps should be connected by fences of sticks and leaves to channel the quarry into them. Some birds and animals can be caught in a baited trap, if their feeding habits are known. All traps should be checked at least once a day to reduce the chance of the catch escaping or being carried off by a predator;
- b. Bats - Many caves or hollow trees are quite often inhabited by colonies of bats which can be flushed into a net by lighting smoky fires in the other inlets, or they can be knocked out with a stick. The larger fruit bats or flying foxes are excellent food.

19. Preparation of Animal Foods - Although the flesh of all animals, birds, reptiles, fish, or insects and their eggs are edible, the following steps should be taken to avoid any possible contamination:

- a. Ensure everything is kept as clean as possible and protected from flies or other insects;
- b. Clean out the contents of the crop, stomach, and intestine to avoid being poisoned or infected by something it has eaten but do not discard, as they are good food when cleaned. Small fish can however be eaten whole and a few days starvation will clear the stomach of most insects;
- c. Remove the poison glands and apparatus of poisonous snakes, fish, and insects. In the case of snakes, this only amounts to removing the head plus a couple of inches of the neck, and is not strictly necessary as their venom does no harm when taken orally, unless there is a break in the tissues of the mouth or alimentary canal. On the other hand, some marine fish and insects with complicated poison mechanisms will have to be discarded altogether;
- d. Skin or singe off fur or feathers and cook thoroughly to destroy any bacteria or parasites.

20. Cooking - Basically jungle cooking amounts to boiling, baking in a fire, or spit roasting, though when fat is obtainable, frying will often improve the flavour and present a pleasant way of eating fat, which has a very high calorie content. Boiling is the least wasteful method of cooking, as the majority of the juices are retained and the water can be made into a broth, unless it has been used to reduce the acidity of some of the bitter plants. Utensils for boiling can be improvised out of sections of bamboo or large, folded leaves which will not burn below the water level.

21. Baking - Baking in the fire may be done in recognizable safe leaves or clay. A hole in the ground should be lined with stones before the fire is built and when a deep pile of embers have built up, they should be raked out and the food wrapped in clay or leaves placed on the hot stones and covered with embers. Skinning or singeing is not necessary with clay cooking as any fur or feathers come off with the baked clay. This is a slow method of cooking and one and a half hours should be allowed for 500 gms (1 lb) of meat.

22. Spit Roasting - Quite the easiest but the most wasteful method of cooking is spit roasting, which nevertheless often enhances the flavour of the food. Care must be taken to ensure that the wood used for spits has no sap or resin.

23. Salt - Salt is lacking in jungle foods and can only be readily obtained by evaporating sea water. Otherwise, small quantities may be collected by burning the fronds of the nipah palm (a trunkless palm similar to attap or bertram, without the celery-like base), and mixing the ash with water to dissolve the salt, then straining it through a cloth to remove the ash before evaporating it. The fruit of this palm is also edible.

24. Preservation - Meat or fish can be preserved by cutting it into thin strips and:
 - a. Drying in the sun;
 - b. Smoking; and
 - c. Salting or pickling in brine, if near the sea. Small fish can be treated whole.

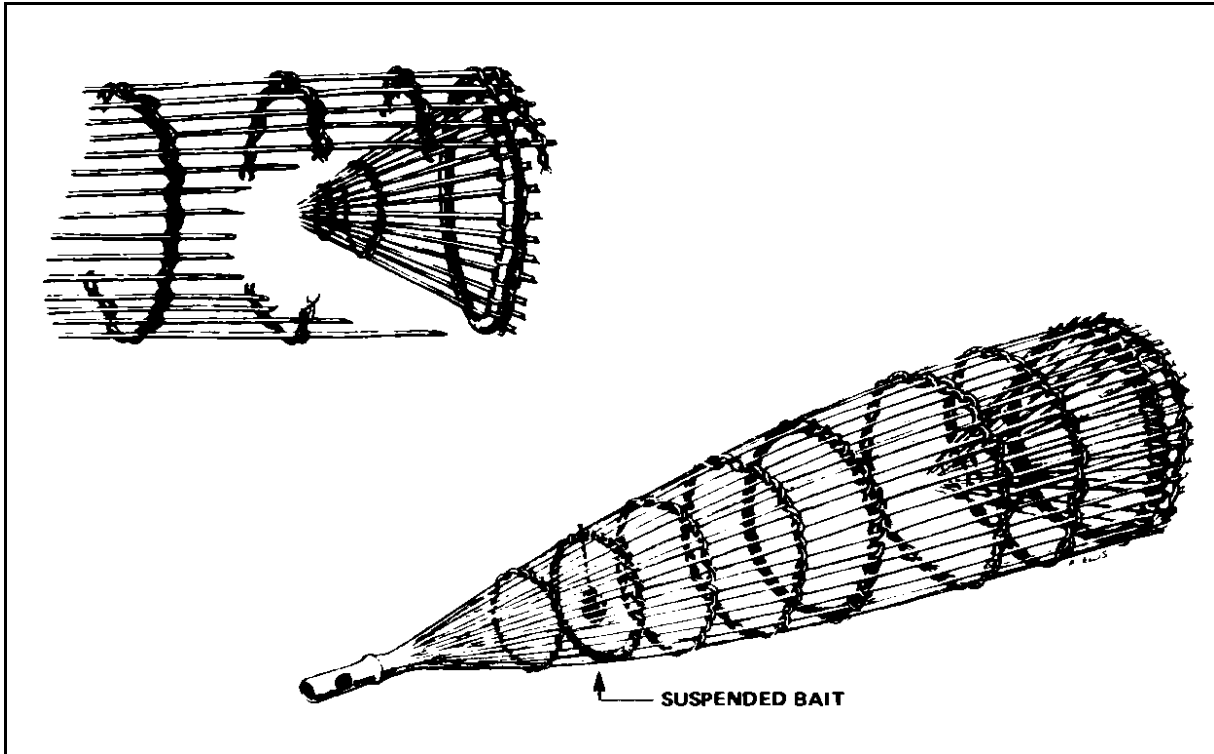

Figure 2-4 Fish Trap

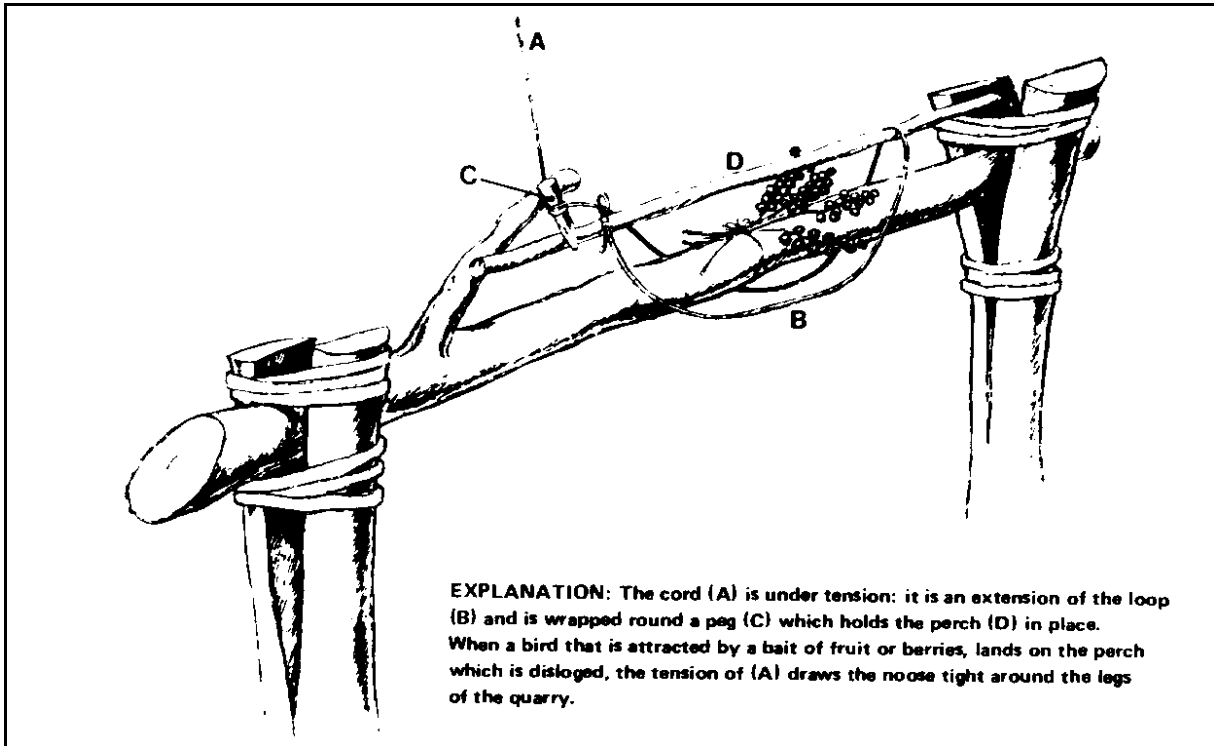

Figure 2-5 Bird Trap

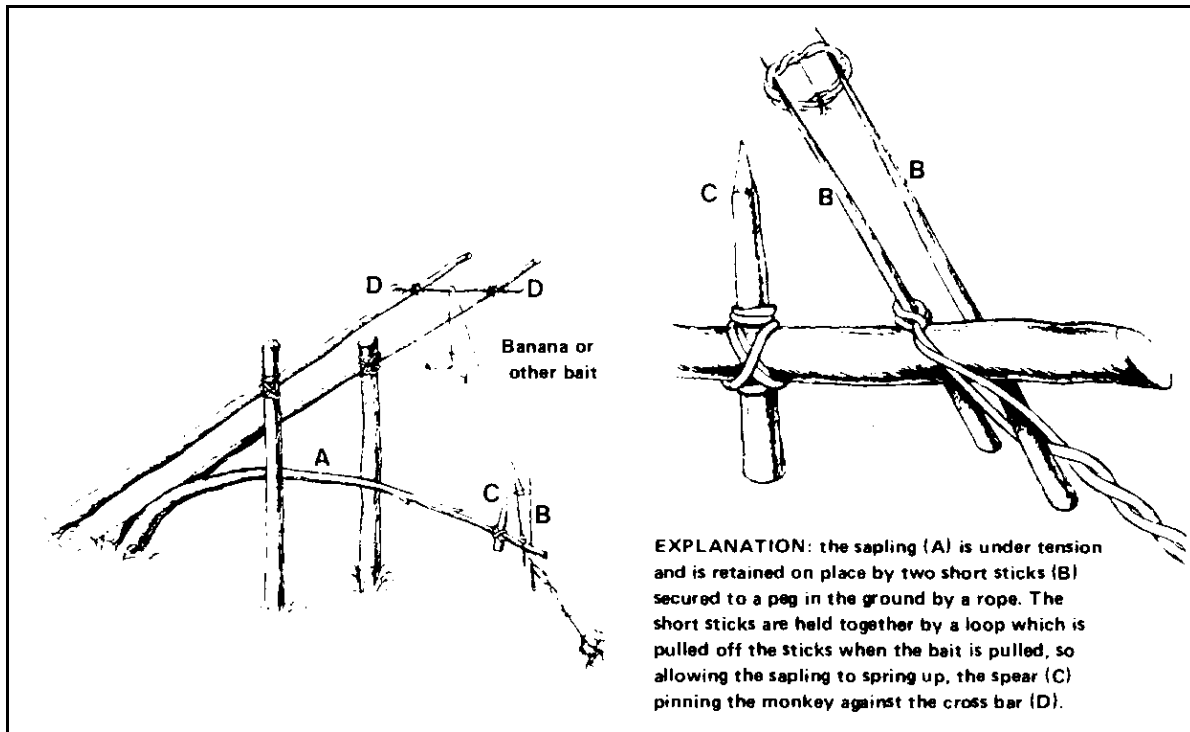

Figure 2-6 Monkey Trap

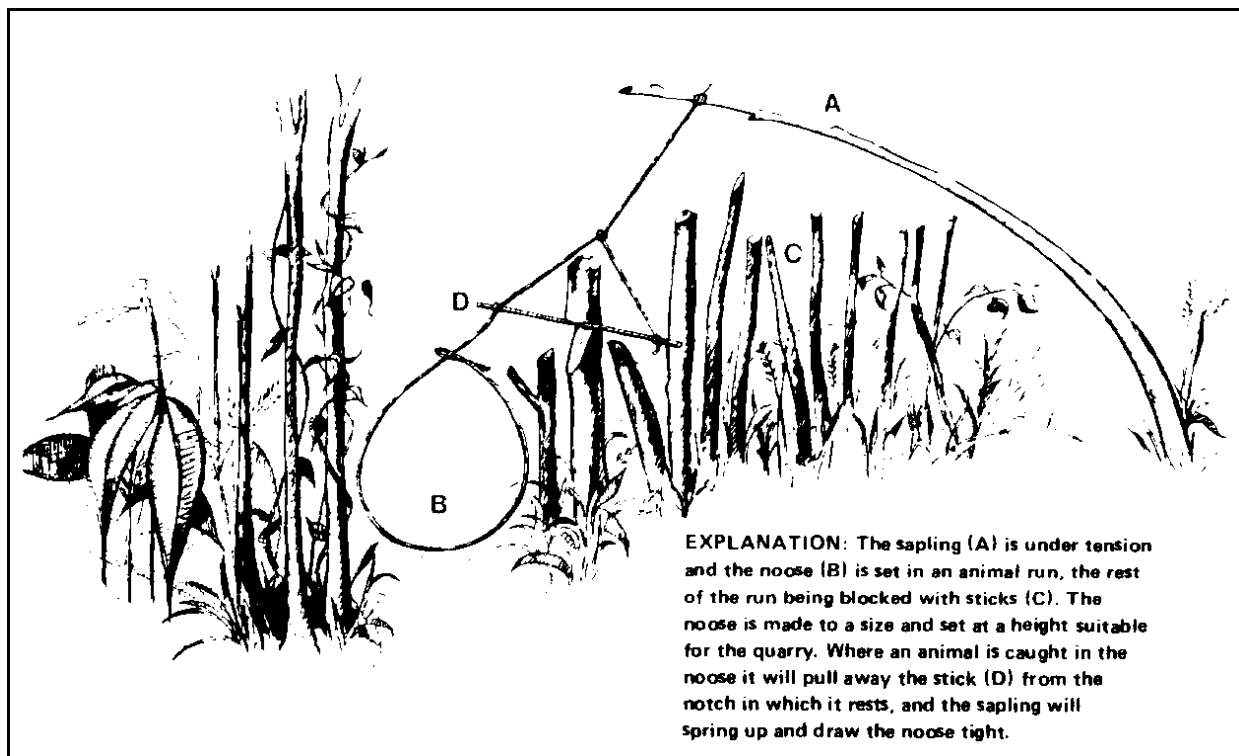

Figure 2-7 Small Animal Trap

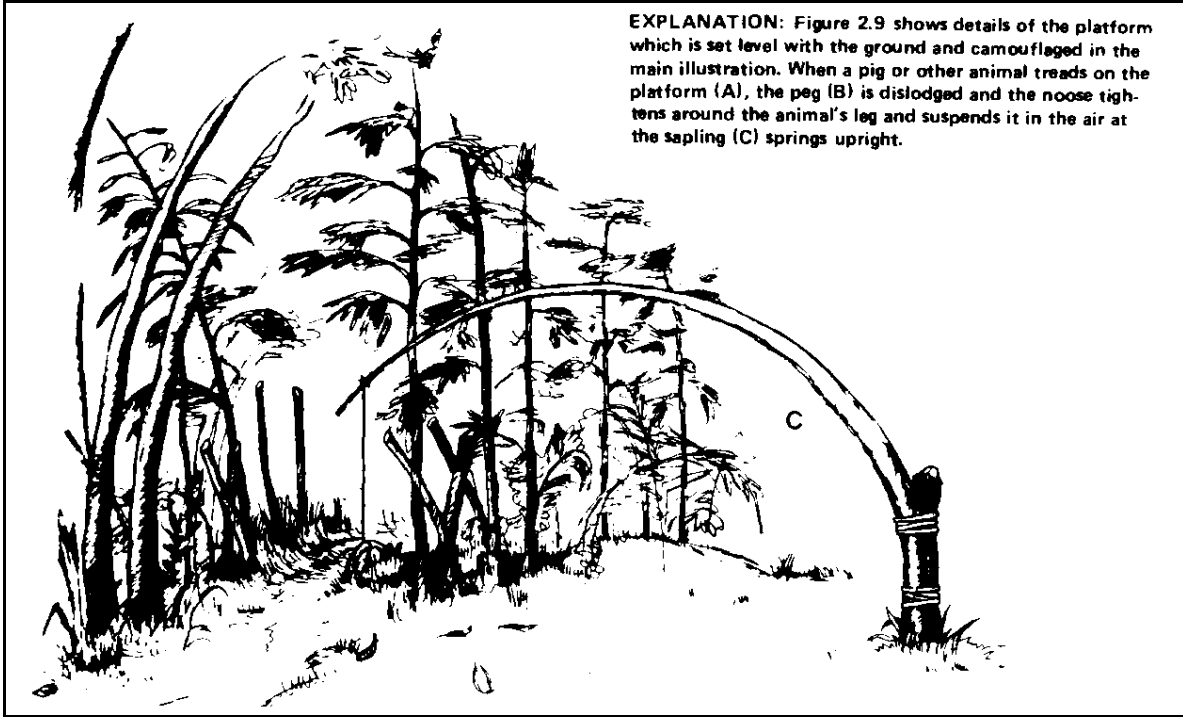

Figure 2-8 Pig Trap

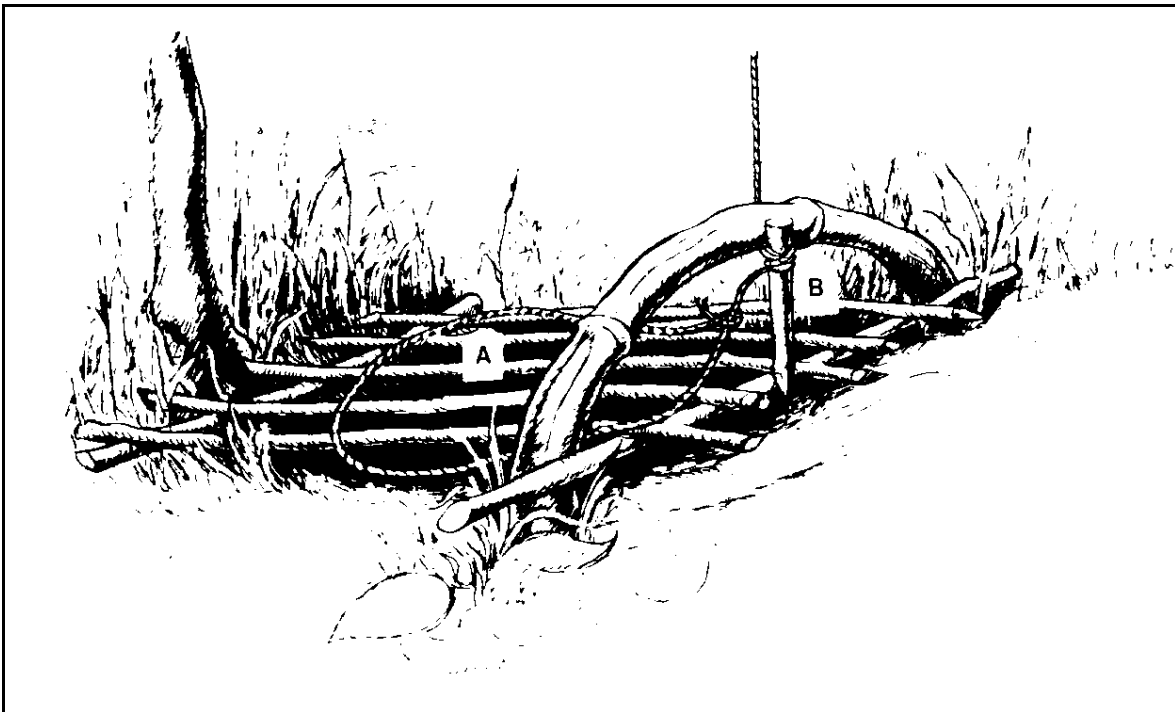

Figure 2-9 Pig Trap - Detail

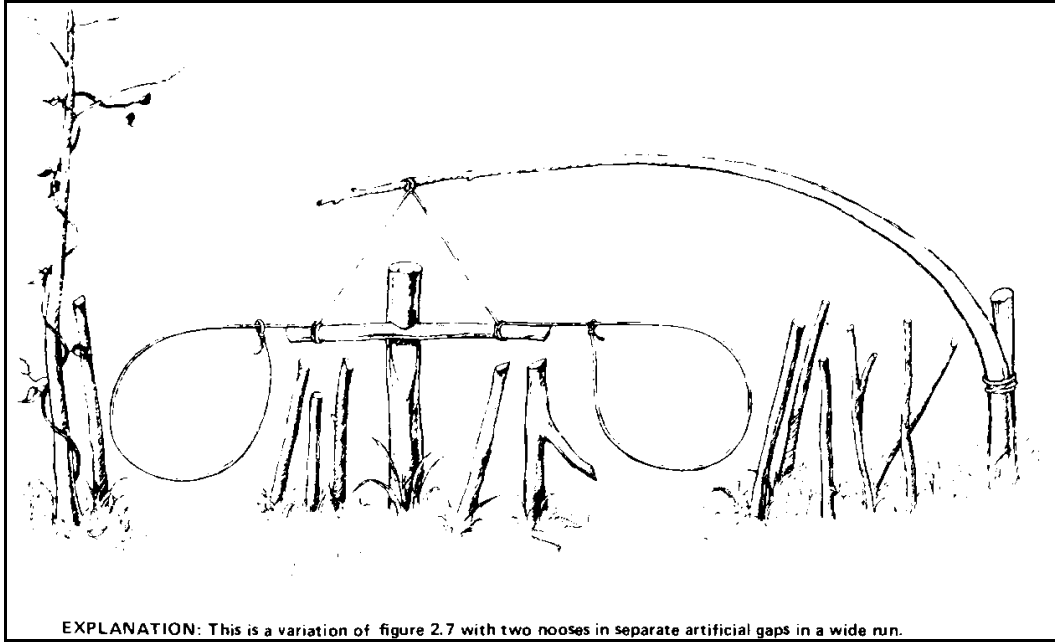

Figure 2-10 Small Animal Trap - Double Noose

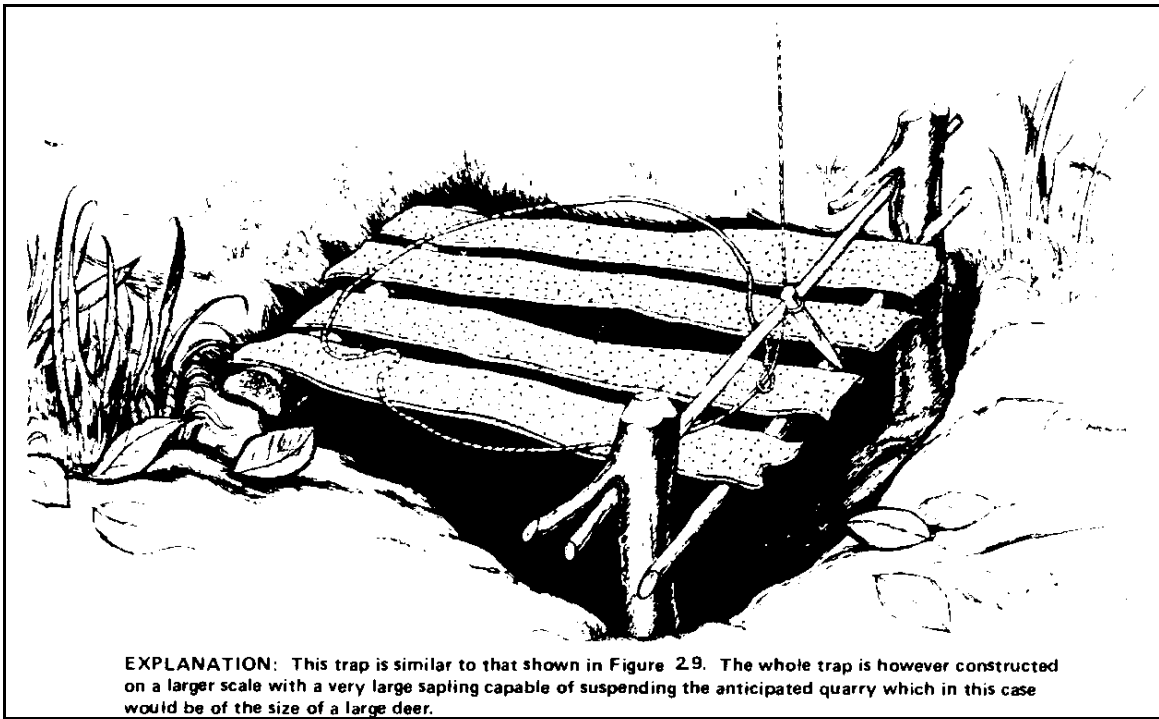

Figure 2-11 Large Animal Trap Type A

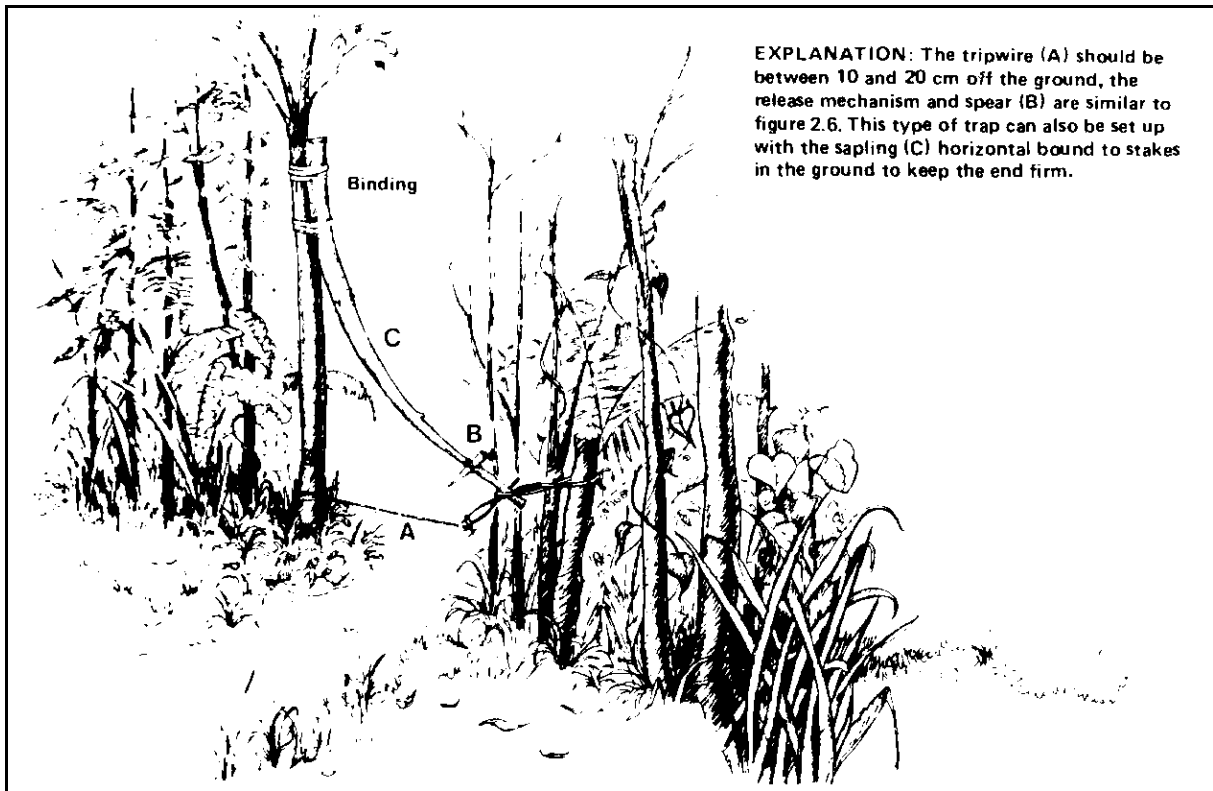

Figure 2-12 Large Animal Trap Type B

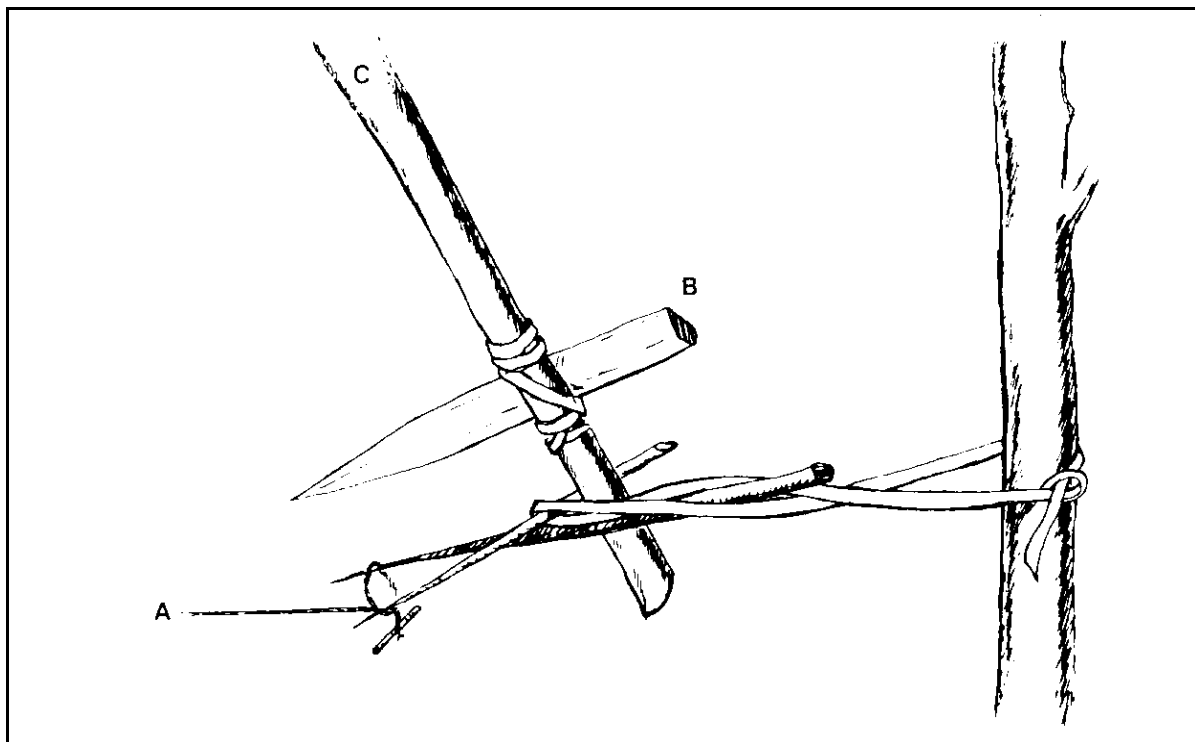

Figure 2-13 Large Animal Trap Type B - Detail

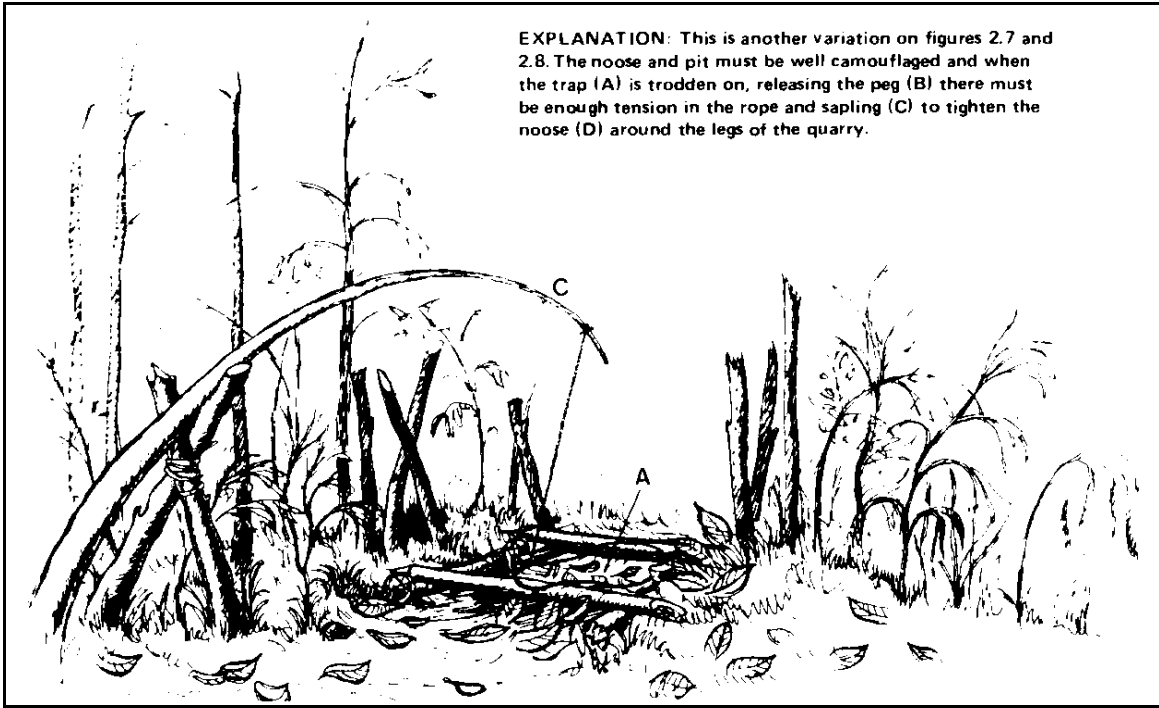

Figure 2-14 Large Animal Trap Type C

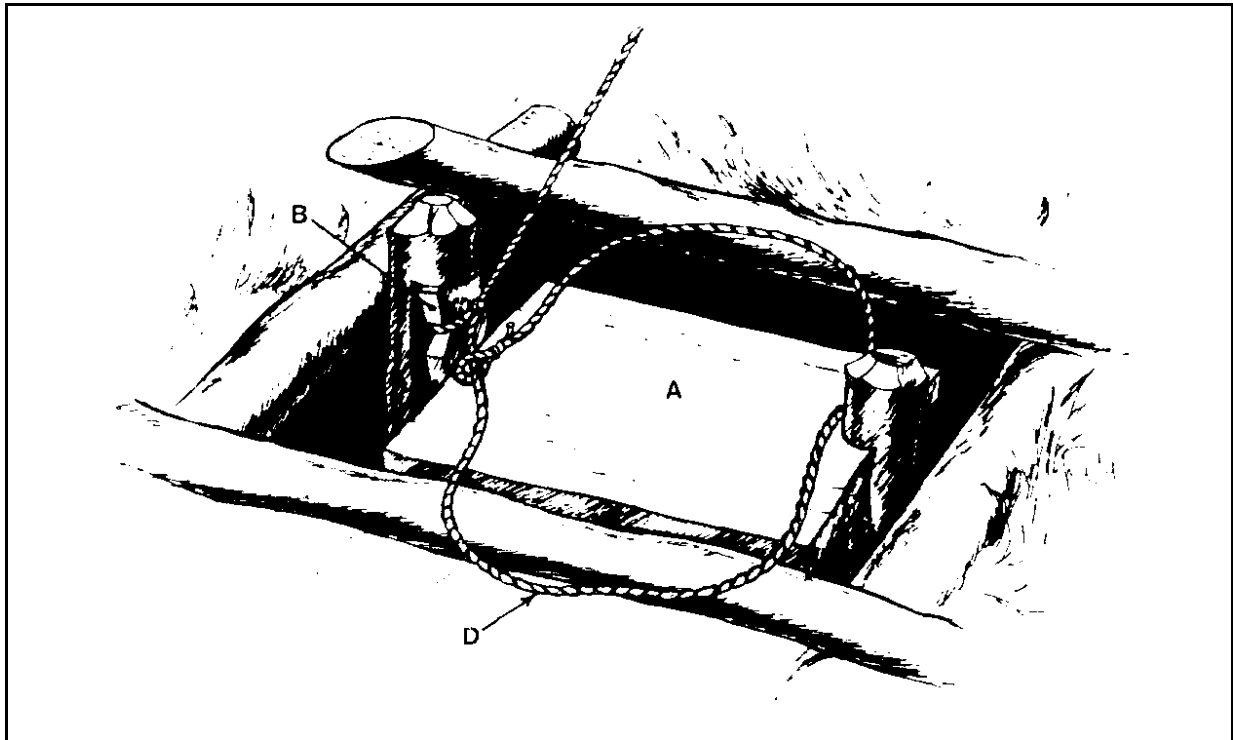

Figure 2-15 Large Animal Trap Type C - Detail

Light Weight Jungle Rations

25. If you use light-weight jungle rations, the length of a patrol can be as much as five weeks. The ration listed below will provide you with enough energy but for the first days you will probably feel hungry until your stomach has shrunk a bit. This scale of ration relies a bit on you living off of your accumulated body fat; so eat well before and between long operations.

26. If a standard light weight ration is not issued, you can very easily make one up yourself using other rations. The one listed below is tasty, light in weight, provides 1,800 calories per day, and provides enough protein, fat, and carbohydrates.

Item	Scale gms	Calories	Protein gr	Fat gr	Carbohydrates gr
Breakfast					
Oatmeal block	31	150	1.8	8.1	18.6
Coffee (instant)	6	8	0.2	-	1.9
Sugar	31	112	-	-	29.8
Milk Powder (skimmed)	15	46	4.9	-	7.0
Snack					
Biscuit	93	414	6.9	15.9	64.8
Cheese (processed)	46	158	9.9	13.0	-
Chocolate	46	246	3.8	16.0	23.2
Main Meal					
Beef granules	77	398	26.8	26.7	13.3
Potato mash powder	62	206	4.8	0.4	45.8
Tea (instant)	2	-	-	-	-
Sugar	31	112	-	-	29.8
Milk Powder (skimmed)	15	46	4.9	-	7.0
Sundries					
Chewing Gum	8	22			6.0
Salt dispenser					
Toilet paper	6 Sheets				
Matches	1 booklet				
Total	463(+)	1918	64.0	80.1	247.2

Table 2-1 Suggested Light Weight Jungle Ration

27. If this ration is consumed continuously for periods in excess of 10 days a period of recuperative feeding must be undertaken.

Cooking

28. If cooking is possible, a pot or mess tin with a tight-fitting lid will save fuel and cut down cooking time. The light-weight jungle ration can all be eaten cold and so you should use it when there is any possibility of the enemy being within the range of cooking smells. Ensure you have a sufficient quantity of heat tablets as suitable dry kindling for smokeless fires may be difficult to find.

Shelter

29. Next to having enough water, protection from weather extremes will be the next most important thing to you. Your body temperature can drop dangerously low in heavy rain or at high altitudes; the simplest aid is to wear waterproof clothing. A good tip also is to carry a light sheet of waterproof green nylon; in case of rain, you'll have a quick shelter. Palm branches can also be used.

30. You must bivouac in pairs so that you can use one ground sheet to lie on and one for cover. Be sure you keep the shelter low and erect it without cutting branches (except in an area where concealment is not important). You can get shelter in a cave, but if it is near running water, it may flood. Also the noise of the water may prevent you from hearing anyone approach.

31. Place your shelter in thick cover and plan several escape routes. Keep it close to water and food but away from dead trees and branches and areas which might flood.

32. If you need string, vines and creepers can be used in their natural state or:

- a. The hard black outershell of bracken fern can be snapped off and the inner stem which provides the string pulled out. It should be a lightish-brown colour without any tinge of green. It is strong enough to make traps, shelters, and clothing;
- b. Bamboo or rattan can be split lengthwise into narrow slivers. These should be whittled down from the inside until only the outer part remains, which is strong enough to make bowstrings;
- c. The inner skin of many types of tree bark can be peeled off in half-inch strips and dried slightly before rolling on the knee or a log. Two or three strands can be rolled or plaited together to make a rope strong enough to support a man's weight.

33. Fire - In the absence of suitable protection, a fire may be essential for warmth and even without matches it does not require a lot of skill to produce one. Dry tinder and a means of producing a spark are required, and the fire must be carefully built up from a small start. Plastic explosive, scrap rubber, slivers of very dry wood, moss, pith, or cotton wool are excellent tinder and should be carried in a waterproof bag or container, even in heavy rain it should be possible to find a sheltered part of a tree or rock containing enough dry tinder to start a fire. The main problem is to produce a spark: in sunlight, a magnifying glass can be used; otherwise, one of the following methods should be attempted:

- a. Flint and Steel - A spark should be struck on to very dry tinder and blown into a flame;
 - b. Bamboo Plunger - By striking a wooden plunger which has been made to fit tightly into a hollow segment of thumb-thick bamboo, heat is engendered by compression and will ignite any very dry pith or cotton wool in the bamboo tube;
 - c. Fire Bow - A hard wood dowel should be twisted into a bow string and revolved rapidly between two soft wood blocks, by drawing the bow backwards and forwards. If the wood is dry enough, the dust worn from the bottom block should begin to glow and can be blown into a flame and fed with dry tinder. A fire bow (preferably spring-operated) should be included in jungle kits;
 - d. Fire Thong - By drawing a length of rattan rapidly backwards and forwards across a small hole in a piece of bamboo, split in half lengthways, bamboo dust is forced into the hole and will ignite in about three minutes if everything is very dry. The bamboo should be wedged firmly and have a shallow groove cut to guide the rattan over the hole, which should be conical and drilled from the inside to meet the groove.
34. Figures 2-16, 2-17, and 2-18 illustrate three simple ways of using a waterproof sheet or poncho to make a shelter. Green nylon cord should be kept attached to the corners and all knots should be slip knots to simplify erecting and packing up.

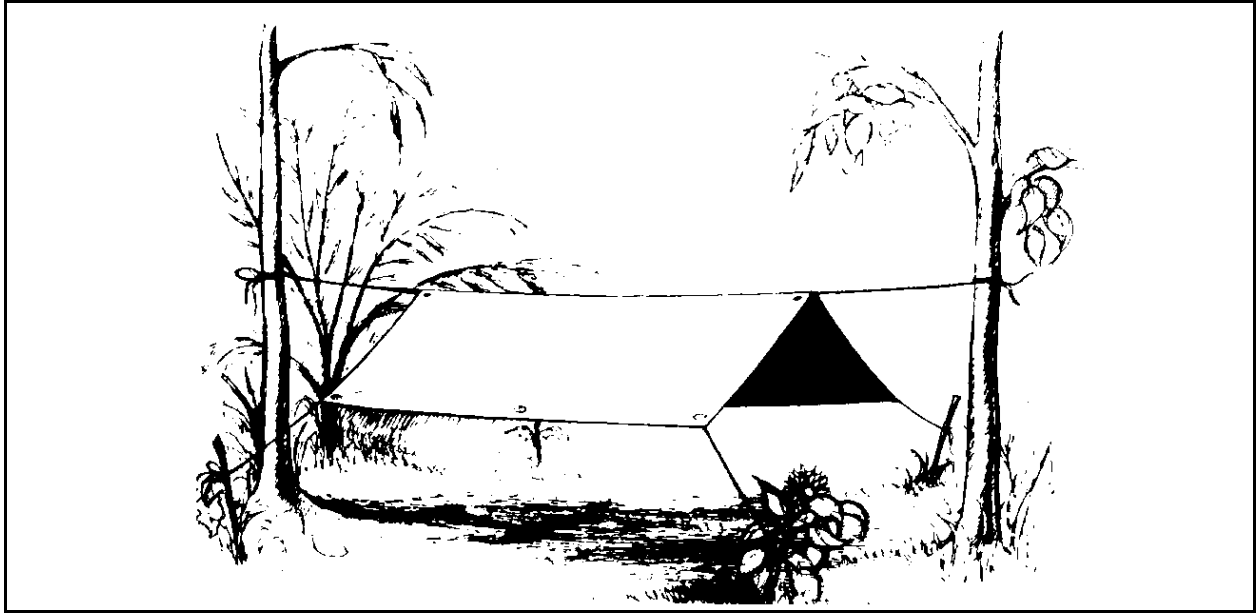

Figure 2-16 Simple Jungle Shelter

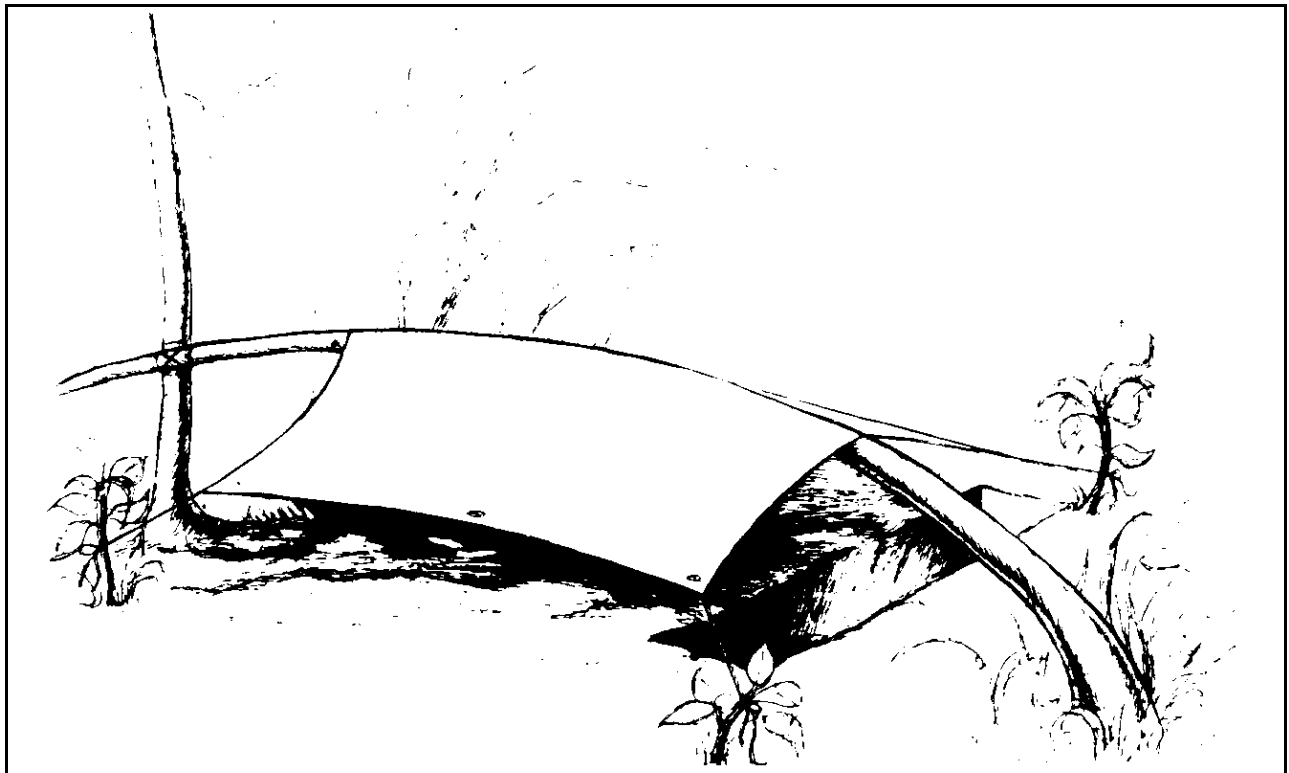

Figure 2-17 Alternative Jungle Shelter

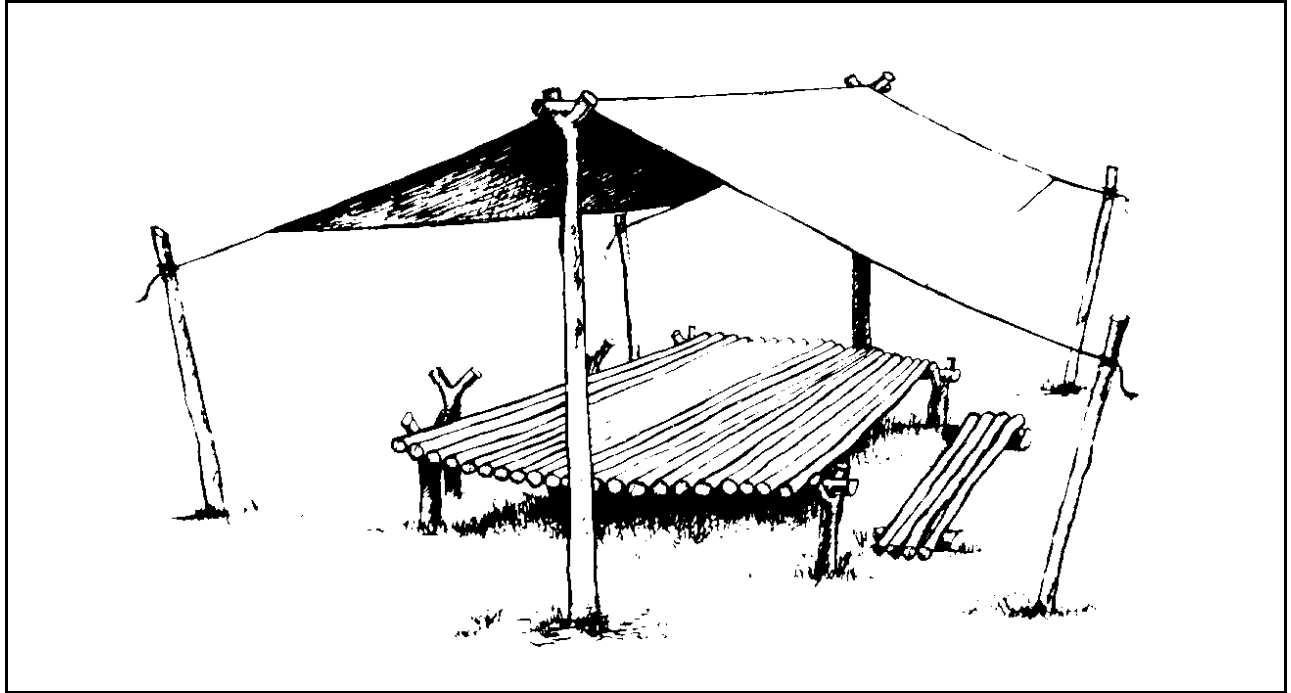

Figure 2-18 Non-tactical Shelter

SECTION 2 - CONCEALMENT AND OBSERVATION

Concealment

35. To avoid detection in the jungle, you must bear in mind the following factors and their implications - sign, noise, smell, shine, shape or shadow, and careless movement.

36. Sign is the name given to marks left by people and animals passing through an area. By avoiding cutting and by leaving no debris, you can reduce sign. You must learn to place your feet lightly on firm ground which will not show sign. You must select a route through thick undergrowth and carefully part the vegetation, rather than forcing or cutting your way through it. Some undergrowth, such as fern, is best traversed by crawling through the relatively clear space at ground level. One of the worst habits you can acquire is to cut your way through the jungle. Cutting is noisy and tiring, it reduces the speed of movement, prejudices the rapid handling of weapons, and leaves marks which cannot be concealed. When cutting is essential, very sharp bush knives should be used, but only to:

- a. Survive;
- b. Clear landing sites (LZs), landing zones (LZs), drop zones (DZs), or routes for casualty evacuation;
- c. Cut poles for stretchers or to secure weapons on fixed lines; and
- d. Clear fields of fire or cut camouflage.

Excreta and waste food should always be buried and camouflaged. Apart from hygienic considerations such debris will not only disclose the passage of troops but may also reveal their discipline, state of health, routine, and types of rations and other supplies. Debris and extra weight can be eliminated by avoiding the use of tins, and rations and other items should be packed in plastic bags which can then be used to carry litter such as matchsticks, cigarette ends, and candy wrappers.

37. Noise:

- a. At times, the jungle is absolutely still. All sounds are then easily heard over considerable distances, especially from above the source. At other times, the noise of rain, wind, rivers, animals, insects, or battle appear to drown all other sounds and this makes it important for troops to be trained to pick out the unusual ones;
- b. A silent force is a sinister one. The longer silence can be maintained, the greater the advantage. Equipment should be packed so that it does not make a noise; sling swivels should be removed or taped; water, dry leaves, and twigs should be avoided; orders should be whispered and silent signals used.

38. Smell - The scent of some food, fuel, tobacco, toilet, and medical items can often be discerned at long distances in the jungle. It must be reduced to the minimum by prohibiting the stronger smelling ones. For example, never use after-shave lotion or deodorant.
39. Shine, Shape, and Shadow:
- a. Providing patches of sunlight and moonlight are avoided, it is easy to keep in shadow in the jungle. Allowance must be made in static positions such as ambushes for the movement of the sun or moon;
 - b. Where possible, all smooth or contrasting surfaces should be covered with hessian and painted a drab flat colour or daubed with mud; binoculars should be used with care to avoid reflection and kept covered when not in use;
 - c. Even in jungle, skylines and regular spacing must be avoided. Outlines should be broken up, taking care when foliage is used for this purpose that it remains fresh, is replaced to match the background and is kept in its natural growing position. Camouflage should not be overdone to the extent of creating mobile bushes.
40. Careless Movement - Despite perfect camouflage, careless movement can reveal a position and the effort and skill required to achieve good concealment will be largely or completely washed.

Observation

41. Visibility in the jungle is normally restricted to a few metres, though sounds and smells can be detected at greater distances. You must therefore rely on all your senses, stopping and listening regularly. This should be every few minutes when in close proximity to the enemy; listening should be accompanied by seeing, smelling, and feeling the atmosphere of the jungle. Eyes should be trained to look through rather than at the foliage, and up as well as down. Enemy may be in the treetops as well as on or below ground level.
42. Immediately any sign, sound, or smell indicates the physical presence of enemy or of such hazards as trip wires and booby-traps, you should freeze or carry out the appropriate immediate action drill.
43. When static, you should continually search your arc of responsibility systematically from side to side in horizontal strips, starting as far as you can see just above ground level and working up to the tree tops, then back down to the foreground. You should then examine the deepest cover more closely using the same sequence.
44. You will be trained in the use of those special optical, electronic, or seismic aids to surveillance which are available, as well as standard night devices. The use of these by the enemy must also be anticipated.

SECTION 3 - COMMUNICATING IN THE JUNGLE

General

45. Although the jungle will make signal communication more difficult, the problems are rarely insurmountable, Common sense and imagination are your most valuable allies. Proper planning for an operation will identify when and where your communication difficulties will occur, how they might be overcome, or at worst confirm where no communications are possible.

46. The problems which you will encounter at section and platoon level generally revolve around three concerns. The first is the reduced range of the very high frequency (VHF), or ultra high frequency (UHF) sets you use because of poor line of sight path. The second is the reduced range and the noisy, fading circuits which are common to high frequency (HF) radio in jungle areas. And of course, the third problem is that the jungle will attack communications gear as readily as anything else. So here is what you do to keep communicating.

Radio Operating

47. To get that line of sight path so essential to VHF or UHF operating, you must know where you are in relation to the other station(s). Site your antenna in the most favorable spot for that direction. Plan to communicate when conditions are favorable such as in clearings or on hillsides. Be prepared to accept a temporary loss of communication particularly when mobile. Proper siting of antennae is the key to VHF/UHF operation. Experiment with different spots. Even a few meters can make all the difference. Get your antenna as high as you can. Some VHF field expedient antennae can be very versatile. Get a few ideas from your signal officer.

48. Remember that airborne or land VHF rebroadcast stations may be prepositioned in your area. Make sure you know where they are and how to use them.

49. Though HF radio will overcome to some extent the line of sight problem, there are other factors which you must consider with these sets. You should site the whip antenna as you would a VHF antenna to get the most out of it. Attempt to get open areas around the base of the antenna particularly in the direction you want to send. Be prepared to work through heavy atmospheric interference; often morse code will get through when voice signals can't. Your HF set will come with a type of dipole antenna which will substantially increase the probability of communications. Learn how to use it, particularly how to get it up and down in a hurry. It's your most valuable antenna.

50. If you deal with HF sets, learn the difference between the various types of signals it puts out and the best type of antenna to use for each. Your signal officer can advise you on this. CFP 322, Communications, Vol 2, Field Radio Operator's Duties and Responsibilities also discusses basic radio propagation and antennal types.

51. Protect your set. You must keep it clean and dry. Learn how to deal with broken antennae, cracked connectors, and the like. Local fix-it methods can often keep the set working until more permanent repair can be effected.

52. Get to know the real capacity of your batteries and keep your own record of operating time. Conserve the life of your batteries by keeping transmissions short. When you use rechargeable batteries, make sure you know how to do it, why it's being done, and what you need. On the trail is no place to experiment. Remember that jungle conditions shorten even the shelf life of batteries. Store yours in a cool, dry place.
53. Do you know your loss of contact drills? If you don't know what frequency you are supposed to be on at any given time as well as what to do when you lose contact, you will surely get lost. The drills are not complicated but you must know and trust them.
54. Remember that sound carries surprisingly far in the jungle. Do not shout into the handset. Use your squelch circuits, volume control, and earpiece to cut the noise down.
55. Remember jungle warfare lends itself to deception and ambush. Do not leave yourself wide open to manipulation; if a radio transmission sounds peculiar, challenge it! Use your authentication system and stay alive.
56. Here are some additional helps to good radio communications learned in Vietnam:
- a. The AN/VRC 12 family of radios must be cleaned daily to avoid overheating due to dust build up around the fan area;
 - b. Antenna sections must be dismantled, cleaned, and lubricated daily if corrosion is to be retarded;
 - c. Keep the PRC 25 set particularly cool as high heat and humidity often causes set failure;
 - d. Check batteries of all types frequently as high humidity often causes electrolyte leakage and terminal corrosion;
 - e. Keep things dry by using plastic bags to hold spare parts, squad sets, etc;
 - f. Keep things cool by shielding equipment with a tarp;
 - g. Don't lose small components of your manpack set on the trail; tie them in with safety cord;
 - h. Keep 100 feet of copper wire handy for expedient antennae;
 - i. Have your signal officer show you different antennae and siting techniques. The sloping V antenna for example has been shown to be effective in Jungle areas. Also, the orientation of all HF dipole antennae on a North-South axis has proven effective in S-E Asia;

- k. Ensure that your base stations have a proper ground for your own protection as well as for efficient operation. Remember that the build up of corrosion is extremely fast at these connectors. Keep them clean;
- m. Keep your antenna masts firmly guyed; the high winds of a tropical storm will severely test them;
- n. Use pipe to shield your antenna transmission cables from the elements and from damage by shrapnel.

Line Operation

57. Your problem with line will be to lay and maintain it. The terrain is often not suited for it, it may frequently be cut by the local population or tapped by the enemy, and you are very vulnerable to ambush when called on to maintain an isolated portion of it. Protection parties are often needed for maintenance crews. This and the amount of line which can be carried at the sub-unit level generally restricts its use to within defended areas.

58. Where you do use line, keep it out of sight unless you wish to lead the enemy to your position.

59. Use your authentication systems even on telephones particularly when you are plugged into outside lines.

60. Keep your line out of puddles and up from the wet ground. Cover junction boxes and test points to keep them dry. Use properly serviced line which is free from cuts and rotted insulation.

61. Ensure switchboards are properly grounded for your own safety.

62. Make sure aerial line is secure against high winds.

63. Keep your equipment clean and dry or it won't work.

Other Means of Personal Communication

64. Common hand signals used in combat are portrayed in Annex A.

CHAPTER 3

NAVIGATION AND TRACKING

SECTION 1 - NAVIGATION

General

1. This subject is covered extensively in CFP 318(8), Maps, Sketching, and Compasses. Only those aspects which pertain specifically to the jungle are mentioned here.
2. Each of you must know how to use a compass. After receiving initial instruction, you must practise. It is a skill that is easily lost.

Limits in the Jungle

3. Except in the case of an absolute emergency, you should never move in the jungle without a compass.
4. You will find your visibility so limited in the jungle that you will most often use night navigational techniques. Maps are often wrong except where major natural features such as mountains or large rivers are concerned.
5. You must therefore navigate by dead-reckoning, that is, by plotting the direction and distance covered and confirm it at main features. The commander will be responsible for finding the way but he will designate others to assist him. In this way, errors can be eliminated. You should know where you are at all times.

Lost Drill

6. As soon as there is doubt about your position, the following drill must be used:
 - a. Stop at once and consider the situation calmly;
 - b. Compare calculations with someone else;
 - c. If there is a recognizable feature in the vicinity, probe on exact bearings and distances until it is located. Otherwise, start from the last definitely accurate position and replot each move carefully allowing for maximum errors; it is a common error to over-estimate the distance covered;
 - d. Draw a circle at the maximum distance that could have been covered from the last known position; then select a major linear feature and follow a bearing to it. Do not move without a check on direction and distance covered;

- e. If without a map, select a bearing in the general direction of a friendly area and stay on it regardless of how long it takes;
 - f. Trackers can be used to back track to the last known position; local guides rarely have any conception of time and distance and if lost, are often inclined to save face by pressing on and thus worsening the situation.
7. The golden rules of jungle navigation to avoid getting lost are:
- a. Never move without a check on direction;
 - b. Count your paces as a check on distance;
 - c. Check each feature, particularly the direction of flow of streams, with a map or against a mental picture (remember that many small streams, hills, and tracks will be encountered which are not on the map);
 - d. Stop and check your position the moment you are in any doubt.

SECTION 2 - TRACKING

General

8. Tracking is an important aid to all types of jungle operation. To be a good tracker requires good eyesight and colour perception, intelligence, a good memory, perseverance, and a high standard of fitness and fieldcraft. As a tracker, you will be part of a team of five including a commander, two trackers, a Radio Operator, and a Medical Assistant. Tracking team tactics (including the use of dogs) are discussed in Part One.

Tracking Sign

9. Sign is the name given to the marks left by animals or humans passing through an area. It will deteriorate in direct sunlight, strong winds, rain, and of course, in time. There are two types, ground sign and top sign, the dividing line being taken at ankle height:

a. Ground Sign - Examples of ground sign are -

- (1) foot or boot marks,
- (2) broken twigs or disturbed leaves,
- (3) bruised or bleeding roots,
- (4) disturbed stones, grass, ground vegetation, or insect life,
- (5) mud and dust deposited from boots,
- (6) debris dropped beside the track,
- (7) disturbed water, and
- (8) blood trails;

b. Top Sign - Examples of top sign are -

- (1) broken or bent twigs, leaves, or grass,
- (2) scratches, bruised moss, or hand holds on trees,
- (3) changes in colour and natural position of vegetation,
- (4) cutting of vegetation,
- (5) torn clothing on branches, and

(6) broken spiders' webs.

10. Sign in Different Types of Jungle -The different types of jungle present varying problems to the tracker. A proficient tracker will be able to distinguish between the sign of men and animals in all conditions. Sign is easiest to find on the banks of streams, in high grass or undergrowth, on steep hillsides, at the edges of clearings, and wherever obstacles canalize the route. Some examples of the effect of the environment are as follows:

- a. Primary Jungle - A wide variety of sign will normally be evident, presenting good opportunities to the tracker;
- b. Secondary Jungle - This is probably the easiest tracking terrain; any movement through it is bound to leave considerable top sign, especially if cutting is involved. The sign will often last a long time;
- c. Grasslands - High grass is easy to track in as it will be bent in the direction of movement. Shorter grass presents more problems;
- d. Rocky Country - This can be difficult to track through, though signs of dislodged stones, scratches left by nailed boots, the disturbing of moss growing on rocks, etc, will all be discernible;
- e. Streams - These are very difficult to track in except when following a hot track or in shallow or still water where footprints may show up;
- f. Plantations - Plantations are very difficult to track in as there is normally little sign and it is easy to mistake tracks of workers for those of the enemy.

11. Information from a Track - A practised tracker should be able to deduce some of the following:

- a. The direction and speed of enemy movement;
- b. Strength;
- c. Time since the track was made;
- d. The load and types of weapons being carried;
- e. Types of ration being used; and
- f. Morale and physical condition of the quarry.

Deception

12. Deceiving a good visual tracker is not easy, though he can be delayed. The tracker should be continually alert to the possibility of deception, and able quickly to detect it by constant careful study of the sign. Some methods of description are:

- a. Walking in a stream - Entry and exit points can normally be found and over-hanging vegetation and cobwebs should be studied carefully;
- b. Fade out - Individuals or pairs may jump to or leave the side of the track. Careful watching of the sides of the track and constant checking of the number being tracked should counter this;
- c. Scatter - If the enemy scatter, the usual procedure is to follow the largest group or easiest track;
- d. A Dead End or False Trail - When this is detected a search must be made back down the track for the turn off point;
- e. Walking Backwards or on Tiptoe - A careful examination of the footprints should determine the direction of movement;
- f. Covering tracks and camouflaging exit points from streams and rivers;
- g. Climbing Trees - The track will end near a tree and there are likely to be marks on the trees;
- h. Use of Donkeys, Boats, Carts, Cars, or Bicycles - Only occurs in inhabited areas and is difficult to counter;
- i. Use of Animal Feet - Can generally be detected by their spacing;
- k. Deliberate laying of track away from food and ammunition dumps and into or near an ambush position;
- m. Walking on fallen logs, rocks, and tarmac roads.

Tracking Drill

13. A suggested tracking drill once a track has been identified is:
 - a. First look ahead and try to see the general direction the track might take;
 - b. Pick out the furthest sign that you can see;
 - c. Back track with the eyes to confirm that this is linked to the track you are following;
 - d. Now check for possible places where the enemy might have left the track;
 - e. When all these checks are completed, move tactically to the furthest sign and repeat the process.

CHAPTER 4

JUNGLE MOVEMENT

SECTION 1 - MOVEMENT

On the Move

1. The jungle does not provide you with much room in which to move. The space that you do find will probably force you into potential ambush areas. Be careful at all times.
2. You should give special attention to the following:
 - a. Move Carefully - Until surprise is lost, keep silent and use hand signals. You must understand perfectly and exactly what your job is;
 - b. Avoid Ambushes - Do not travel on tracks, travel by the use of compass;
 - c. Observe - Each man will have a specific area of responsibility. Look behind you frequently. The last man will have the rear as his specific responsibility;
 - d. Speed - The speed will be laid down by the commander. If you move silently, you will move slowly. The pace should not be forced. If you are tired, you will not be fully alert;
 - e. Control - When travelling in column, control is from front to rear. Each person must continually check that the man behind is following and halt if he is not. If the column has split, the rear portion will backtrack to find it. Commanders will be well forward;
 - f. Formations - The jungle forces single file, but arrowheads should be used whenever possible. You should be eight paces from your neighbour as long as you can see him;
 - g. Night - To move silently at night, careful planning and route selection are needed. Bearings and distances, must be exactly followed. An action fought at night is usually confused.

At the Halt

3. Because an approaching enemy will be using cover, you are very vulnerable when halted. Halts can be divided into:
 - a. Pauses of only a few minutes - long enough for some recce, navigation checks, to listen, or perhaps refill water bottles;
 - b. Short halts of up to half an hour for a more detailed recce, to make a plan, rest, or eat;

- c. Long halts when the situation demands or permits, for purposes of resting, eating, cooking, washing, or perhaps to prepare a DZ or ambush;
 - d. Lying-up positions which are used as resting places only. No cooking, washing, radio traffic, or other noisy tasks will be permitted;
 - e. Harbour areas which will be used for a patrol base, assembly area, or other long term task.
4. When you halt, intense vigilance is required. The immediate ambush drill rear will be carried out immediately on halting (except in the case of the pauses). This drill will catch any enemy following you. The drill will be taught as outlined in CFP 302(4), Part One.
5. It is also important to have a deception plan. This plan can be put into effect before, during and after halts.

In Transport

6. When moving in transport, you are more likely to be ambushed than when on foot. This is because you are confined to roads and tracks. Anti-ambush drills will be practised and must be remembered.
7. Before taking part in a move, you will be briefed on the following:
- a. Composition, order of march, objectives, routes, and timings;
 - b. Who the commander, deputy commander, and sentries are;
 - c. Communications including radio, light, flag, smoke, hand, and other signals; and
 - d. Action to be taken -
 - (1) if ambushed, fired at, lost or broken down, sunk or crashed,
 - (2) at obstacles, halts, and dangerous areas,
 - (3) on dismounting, and
 - (4) in an emergency.
8. You must also ensure that the points listed are observed:
- a. Remove vehicle superstructure to ensure you have a clear field of fire and can dismount quickly. Sandbags on the floor will protect against mines;

- b. All vehicles should have machine-gun (MG) mounts and high angle-iron wire cutters. Claymore mines which can be set off when needed can be put on the sides of vehicles. These must be mounted on steel plates to protect the passengers from back-blast. Callsigns painted on the top of your vehicle will make air identification easier;
- c. All vehicles must have complete tool kits and mine detectors; strong rope or chain must be available for clearing or towing obstacles;
- d. Helicopters should have at least 60 metres of knotted climbing rope or the same capability through the use of a winch;
- e. Obstacle and counter-ambush drills must be practised before you move. If you feel that the enemy knows your drill, then vary it a little;
- f. Do not put all your troops, weapons, or equipment in one vehicle. However, sections or crews should be together. Pack your stores in the centre and the troops sit facing outwards. Heavy weapons such as mortars and rocket launchers should be mounted if possible. All personnel must be fully alert with equipment worn and weapons ready;
- g. Sentries will be detailed and one will be travelling with the driver to protect or assist him. If ambushed, the driver's sentry will remain in place and not take part in any counter-attack. Commanders will be travelling in the main passenger compartment and not in the cab;
- h. If travelling by water, all craft must carry paddles, tow ropes, and marker buoys. All stores will be secured to the craft and crew and passengers will wear life jackets. Personal weapons will be secured to the body by a long nylon cord;
- j. When trains are used, side sentries must watch for enemy seeking to board or uncouple cars.

Lost Drill

9. Once you have determined that you are indeed lost or if there is any doubt about your exact position, you should carry out the following drill:

- a. Stop at once and make a calm appreciation;
- b. Compare thoughts and calculations with someone else;
- c. If there is a recognizable feature in the area, probe for it on exact bearings and distances until it is located. Otherwise, start from the last definitely accurate position and repeat each move carefully allowing for maximum errors. It is a common error to over-estimate the distance covered;

- d. Draw a circle at the maximum distance that could have been covered from the last known position, then select a major linear feature and follow a bearing to it. Do not move without a check on direction and distance covered;
 - e. If you do not have a map, select a bearing in the general direction of a friendly area and stay on it regardless of how long it takes.
2. Follow the golden rules of navigation:
- a. Never move without a check on direction;
 - b. Count your paces;
 - c. Check each feature, particularly the direction of flow of streams, with a map or against a mental picture. Remember that you will encounter many small streams, hills, and tracks which are not on the map;
 - d. If in doubt - stop and check your position.

CHAPTER 5

HEALTH

SECTION 1 - PERSONAL PROTECTION

Basic Essentials

1. The hot and humid climate, the terrain, and the natural jungle diseases increase greatly the hazard to health. It is also very difficult to move the sick and wounded to proper treatment locations. In the past, far greater casualties have been caused by sickness than by enemy action. Only a high standard of health discipline will reverse this trend.

2. Before arrival in a jungle area:

- a. The medical officer (MO) will weed out the unfit and ensure that all personnel are vaccinated and immunized;
- b. You will be trained in health, hygiene, and water duties;
- c. A cadre of first aid instructors will have been trained. These people will instruct everyone in the unit in basic first aid. At least two men in each will receive further training and will be used as patrol medical section will assistants and will be capable of caring for casualties when normal medical facilities are not available;
- d. A progressive program of physical endurance training will be carried out to ensure the health and stamina to withstand the climate and build up of resistance to disease.

3. For your personal protection, follow these basic points:

- a. Keep in top physical condition;
- b. Obey medical instructions;
- c. Take prompt first aid measures to prevent infection;
- d. Eat a balanced diet and drink plenty of sterilized water; and
- e. Keep clean.

Mosquito Borne Diseases

4. The principle diseases carried by mosquitoes are:

- a. Malaria;

- b. Dengue fever (an infectious eruptive fever causing acute pains in the joints);
 - c. Filariasis (the introduction of a parasitic worm into the blood);
 - d. Encephalitis (inflammation of the brain, it is distinct from sleeping sickness, although both have lethargy as a symptom); and
 - e. Yellow fever.
5. Each of these diseases is spread by a mosquito which itself has become infected by sucking blood from an infected human or infected animal. The main methods of prevention are:
- a. The taking of your anti-malaria pil or pills. This will be done under strict supervision and is the most important single measure you can take to prevent malaria;
 - b. Covering arms and legs with clothing;
 - c. Sleeping under mosquito nets which have been erected before dusk - if nets are not available, then wear a head veil;
 - d. Preventing mosquitoes from breeding by treatment of all stagnant water. On a weekly basis, all static collections of water such as fire buckets must be emptied and refilled with clean water;
 - e. Destroying with insecticide sprays;
 - f. Siting camps at least half a mile from other human habitation; and
 - g. Using personal mosquito repellent every two hours.

Scrub Typhus

6. This disease is marked by a fever, eruption of purple spots, and usually delirium. It is spread by one bite of an infected bug which normally lives on the ears of rats. The rats are usually found in long grass, secondary jungle, and near or in inhabited areas.
7. To prevent the catching of the disease:
- a. Fumigate your clothing with the appropriate insecticide before entering and after leaving the jungle;
 - b. Sleep off the ground; and
 - c. Harbour away from long grass, secondary jungle, and houses.

Bowel Disease

8. These are spread by faeces from a person with the disease contaminating food and water. It is transmitted most by infected water, flies and other insects, and the fingers of carriers.
9. Preventive measures include:
 - a. Treatment of all water;
 - b. Examination and documentation of all food handlers to prevent symptomless carriers being employed;
 - c. Protecting food from flies;
 - d. Sterilization of raw vegetables and fruit and with a water sterilizing powder mixture;
 - e. Disposal of waste matter by burning or burying in a pit at least 2.5 metres (8 feet) deep. Individuals should defecate in a shallow trench and then bury their faeces;
 - f. Strict attention to latrine hygiene; and
 - g. Cleanliness of mess tins and knife, fork, and spoon (KFS) combination.

Heat Illness

10. Heat-stroke - This is a breakdown of the temperature regulating devices of the body. It can cause death if not treated rapidly. It may follow a fever and can be combined with malaria. Warning signs include headaches, dizziness, restlessness, irritability, and frequent urination together with a stopping of sweating. The victim may be delirious, have convulsions, and go into a coma. It comes quickly, consciousness will be lost at +41°C (106°F) and within 15 minutes, the casualty may be in a deep coma with a temperature very high. His face will be congested, the skin hot, dry, and burning and the breathing fast and noisy.
11. Heat Exhaustion - Will more commonly be found in those who are unacclimatized and who are not used to strenuous physical activity. Those who are weakened by illness such as diarrhoea and vomiting are also likely to suffer heat exhaustion easily. It is caused by a lack of salt and water. Symptoms are weakness, headaches, dizziness, nausea, vomiting, and mental confusion and it usually occurs during physical activity and arrives gradually. The casualty appears pale, exhausted, cool, and sweaty; his pulse rate will be rapid and the blood pressure low.
12. The most important measures which can be taken to help prevent heat illness are:
 - a. Keep physically and mentally fit;
 - b. Take time to become acclimatized. This can be partially achieved in five to seven days and can be largely completed in about two weeks;

- c. In the humidity of the jungle, it is possible to lose large quantities of water from the body without feeling thirsty. Water discipline in the jungle means that everyone must drink enough.

Skin Disease

13. Skin disease causes the biggest waste of manpower. Because of constant sweating and frequent immersion in water, the skin becomes soft and prone to injury and infection by fungus and bacteria.

14. It can be prevented by:

- a. Strict attention to personal cleanliness; wash and dry your body each day if possible;
- b. Use plenty of foot and body powder;
- c. Promptly give first aid to cuts and scratches; and
- d. Regular skin inspections, so that cases can be detected and treated early.

SECTION 2 - FIELD TREATMENT

General

15. Because a medical officer may be a long time away and air transport is not available or cannot be used, it is essential that all are trained in first aid and know the contents of individual and section medical packs. As pointed out in Chap 5, para 2c, personnel are also trained as lay medical assistants.

16. A medical officer will normally be located at unit headquarters from where he can provide treatment and advise by radio. Whenever possible, he will conduct first aid training.

Medical Packs

17. Each man will carry a shell dressing and a small individual medical pack which will become his survival medical pack if cut off. Each section and like-size group will carry a larger medical pack. (See Tables 5-1 and 5-2.)

Treatment

18. When the medical orderly or commander is in doubt about a patient's condition or when evacuation is considered necessary, a medical officer should be consulted by radio. A standard sequence for this type of request should be laid down in Standard Operating Procedures (SOPs). An unhurried diagnosis can then be made before acting. However, emergencies may occur involving severe bleeding or an inability to breathe which will require immediate action and the first aid training of all personnel should enable them to act in these circumstances. The aims of such treatment are to:

- a. Save life;
- b. Prevent deterioration of the patient's condition;
- c. Prepare the patient for evacuation if his condition is serious; and
- d. Cure minor illnesses and injuries.

Serial	Item	Grams	Remarks
1	1 Waterproof container with instructions for use printed on outside.	20	
2	Morphine syrettes	12	In light waterproof containers. (carried by officers and Sr NCOs only)
3	1 Plastic bottle gentian violet in spirit.	60	
4	30 Chalk and opium tablets.	16	In light waterproof containers.
5	20 Neomycin sulphate tablets.	16	
6	20 Tetracycline tablets.	16	
7	20 Codeine tablets.	16	
8	10 Assorted bandaids.	14	
	Total	170 grms	

Table 5-1 Suggested Contents of Individual Medical Pack

Serial	Item	Grams
1	1 Waterproof container with instructions for use printed on outside.	20
2	1 Roll 7.5 cm (3 in) adhesive tape	90
3	1 Roll zinc oxide dressing	50
4	2 Triangular bandages	90
5	4 Size 10 dressings	68
6	5 Size 11 dressings	45
7	2 Packs sterile gauze	20
8	2 Packs of 3 cotton wool balls	10
9	10 Assorted bandaids	14
10	1 Pair disposable forceps	5
11	1 Clinical thermometer	5
12	4 Suture needles	5

13	6 Safety pins	5
14	1 Plastic bottle acriflavine solution	55
15	1 Plastic bottle gentian violet in spirit	60
16	1 Bottle otosporin ear drops	27
17	1 Tube neomycin sulphate ointment	36
18	1 Tube nupercainal ointment	36
19	1 Tube aureomycin ophthalmic ointment	5
20	1 Tube provifast dental ointment	7
21	40 Soluble aspirin tablets in plastic strip	18
22	30 Piritor tablets in plastic strip	5
23	20 Ducolax tablets in plastic strip	4
	Total	680 grams

Table 5-2 Suggested Contents of Section Medical Pack

19. In your first aid training, you will receive instruction in the following:
 - a. Prevention of haemorrhaging;
 - b. Closure of chest wounds;
 - c. Application of field and shell dressings;
 - d. Artificial respiration;
 - e. Maintaining breathing in unconscious patients and those with facial injuries;
 - f. Splinting limbs with available material;
 - g. Careful handling to minimize shock;
 - h. Treatment for shock; and
 - j. Use of morphine in cases of great pain. The quantity of morphine and the time at which it is given must be noted on a card attached to the patient in a prominent position.
20. The following require urgent evacuation and are not unduly upset by travelling:
 - a. Perforated chest wounds; and
 - b. Serious head injuries.
21. Skilled medical attention should if possible be brought to the following cases before evacuation, as they travel badly:
 - a. Perforated abdominal wounds; and
 - b. Broken thigh bones and backs.
22. The following simple jungle medicines may be used to treat diarrhoea and cuts or sores:
 - a. Diarrhoea - Small quantities of charcoal should be eaten, or the water in which roots of wild ginger have been boiled, drunk. The latter should be boiled in several changes of water, until the resultant brew is weak enough to be held in the mouth for a few minutes, without discomfort, before being drunk;
 - b. Cuts and Sores - Large millipedes give off an iodine-like substance which can be used to treat cuts and sores or the crushed leaves of the pokok kedudek may be used as a dressing. This is a shrub with a reddish-brown stem and small brown or black edible " Hip" like berries. The narrow, pointed leaves are about 7.5 cm to 10.5 cm long and have three main veins running from their stem to their point.

Snakebite

23. The immediate first aid measures to be taken are the same regardless of the type of bite:
 - a. The casualty must be put to rest and the bitten extremity immobilized;
 - b. The bite should be washed with water to remove any venom around the wound;
 - c. A tourniquet should be placed approximately 5 cm above the wound site if an extremity is involved or above any swelling that may have occurred. The purpose of the tourniquet is to slow the passage of venom back through the venous and lymphatic vessels but not to cut off the arterial circulation; therefore, a pulse should still be felt beyond the tourniquet which would indicate not too much tension has been used. The tourniquet must be loosened for 1 to 2 minutes every 15 to 20 minutes and moved up the limb in advance of further swelling;
 - d. Respiratory arrest should be treated in the usual manner with mouth to mouth resuscitation;
 - e. The casualty must be evacuated as quickly as possible for further treatment and observation in hospital.

SECTION 3 - CASUALTY EVACUATION

Aim

24. Apart from the humane considerations of saving life and alleviating suffering, the immediate military aim of casualty evacuation is to free the fighting troops from the encumbrance of casualties. Prompt skilled medical will also ensure that the sick and wounded are left out of battle for as short a time as possible. A further factor is the importance to morale of the knowledge that because evacuation lines will be difficult, medical sections will be located as far forward as possible so that troops will be well cared for if they become casualties. It is thus necessary to assess the relative importance of id evacuation and the tactical needs of the situation.

Considerations

25. Circumstances which will dictate the degree of priority to be given to casualty evacuation and factors to be taken into account are:

- a. In the case of deep patrols the possibility of jeopardizing the mission;
- b. The risk of further casualties resulting from revealing positions; and
- c. The risk to helicopters and their crews.

These must be balanced against the liability which an unfit, let alone a seriously ill man, can be on an operation.

26. When evacuation is tactically unacceptable, there are three other alternatives,

- a. To bring skilled medical attention to the casualty. Although this is often easier than evacuating a patient, it does not preclude the possibility of having to evacuate him later. It is also an uneconomical way of using skilled manpower which is also exposed to unnecessary risks;
- b. To give the casualty as much treatment as possible and leave him in hiding with sufficient food, medicines and water, with medical attention or an escort; and
- c. In extreme cases, to treat casualties and then leave them where they will be found by the enemy or by local inhabitants.

27. In certain favourable circumstances, it may be possible to combine the first two alternatives and leave casualties in hiding, bringing skilled medical attention to them; thus a sort of concealed field hospital is established which can be evacuated when the situation allows.

Evacuation Priorities

28. All unfit men who are a liability to operations should if possible be evacuated. This seldom presents a major problem in the case of slightly sick and walking wounded: they can walk out to a prearranged pick up point, or in the case of a deep penetration operation they can man a rendezvous (RZ) until the force is extracted. The priorities for evacuation are:

a. Urgent cases which require immediate evacuation (but see Chap 5, para 25) -

- (1) major haemorrhages,
- (2) extensive burns,
- (3) serious wounds of the chest or abdomen,
- (4) severe multiple wounds,
- (5) major fractures,
- (6) severe head injuries, and
- (7) heat stroke;

b. Less urgent cases which require early evacuation -

- (1) spinal, eye, and facial injuries, and
- (2) flesh wounds requiring cleansing;

c. Cases which should be evacuated when possible -

- (1) lesser fractures and dislocations, and
- (2) medical cases which have not responded to treatment.

Recovering Battle Casualties

29. Battle casualties tend to get lost and sometimes not even noticed in jungle fighting; it is therefore important that you note where your comrades have fallen so that you can guide a recovery party back when the opportunity occurs. Such parties must be prepared to find the dead and wounded booby-trapped.

30. Whatever method of evacuation is employed, casualties will usually have to be carried over rough ground and through thick undergrowth, often for long distances. All patrols must therefore practise drills for the tactical evacuation of casualties: if possible, the carrying ground should be covered by an escort group and preceded by another group to clear the way.

31. Once they have been removed from danger, which may necessitate their being dragged away from enemy fire, the three main methods of carrying casualties in the jungle are:
- a. Jungle Litter - An improvised stretcher made of finger-thick saplings or bamboo bound together with cord or creepers and slung under a long pole: this can be carried on men's shoulders or by two pack animals;
 - b. Improvised Stretcher - Made from a shelter sheet or air marker panel and two long jungle poles. As far as his injuries permit, the patient must be firmly secured to any type of stretcher at the shoulders, hips, and calves to prevent him sliding or falling off;
 - c. Pick-a-Back - The casualty can be carried on a soldier or porter's back supported by a flat band of fabric, bark, or creeper under his buttocks and over the forehead of the carrier. Depending on his state of consciousness and the going, the patient may also need to be secured by a second band under his legs, in front of the carrier, and over his own shoulders. In difficult country, this may be the only feasible way of carrying a casualty as it leaves the carrier's hands free to help him negotiate obstacles.

Helicopter Evacuation

32. The three most usual methods of evacuation by helicopter are:
- a. By Winch - When the helicopter cannot land or hover low enough to take the casualty aboard, the patient can be firmly secured in a litter and winched or lifted on the end of a rope. In primary jungle, the helicopter may need to lower up to 100 metres of rope, which must have enough weight on the end to penetrate the canopy and reach the ground through undergrowth;
 - b. Low Hover - On soft, uneven, or incompletely cleared areas, helicopters can often hover low enough to load casualties without landing;
 - c. From an LS - The loading of casualties is easier and can be accomplished quickly.
33. Casualty pick up points below the canopy can be marked by a beacon marker balloon, or smoke. Marker panels or lights can also be used to mark LSs and hover sites.

Other Means of Evacuation

34. Once casualties have been carried to a road, track, landing strip, or water by troops, porters, pack animals, or helicopters, further evacuation can take place by any means. These may include local vehicles, carts, bicycles, rafts, boats, hovercraft, and aircraft. In all cases, patients need to be well secured to prevent unnecessary movement aggravating their condition.

SILENT HAND SIGNALS

The hand signals listed in the table must be mastered by all personnel.

Serial	Meaning	Signal
1	Deploy	The arm extended below shoulder level and waved slowly from side to side with the hand open.
2	Advance or Follow Me	The arm is swung from rear to front below the shoulder (or above the shoulder only if the undergrowth prevents the former).
3	Halt	The arm is raised until the open hand is level with the shoulder.
4	Go Back or Turn Round	The hand is circled at hip height.
5	Enemy Seen or Suspected	Fist clenched, thumb pointed down towards the ground.
6	No Enemy in Sight or all Clear	Fist clenched, thumb pointed upwards.
7	Support Group General Purpose Machine-gun (GPMG) group	Fist Clenched.
8	Reconnaissance Group	Fist clenched with forefinger upright.
9	Rifle Group	The victory sign.
10	Platoon Commander	Two fingers placed on shoulder to indicate officers.
11	Section Commander	Three fingers held against arm to indicate sergeant's stripes.
12	Cover Me	Weapon brought into the aim.
13	Give Covering Fire	A punching movement with the fist in the direction required.
14	Track Junction or Obstacle	Arms crossed or first and second fingers crossed.
15	House or Hut	Hands formed into a inverted V to indicate the shape of the roof.
16	Reconnaissance	Hand held up to eye as though using a telescope.

17	Attack	A chopping movement with the edge of the open hand in direction
18	Immediate Ambush	attack is required.
19	Freeze and Listen	Hand placed over face followed by pointing to place of ambush.
20	O Group	Hand cupped to ear.
21	Arrowhead Formation	Fingers together and moved in conjunction with thumb to simulate
22	Extended Line Formation	person talking.
23	Right or Left Flanking	Both arms extended behind the back in the form of a V or above
24	Space Out	the shoulders if the undergrowth is too tall.
25	Adopt Temporary Defensive Position	Hands joined to form a circle above the head, then point to area required and indicate arc of responsibility by extending arms in a V.
<p>NOTE: Signals must be repeated clearly from man to man along the column and acknowledgement takes the form of the giver seeing the receiver passing the signal to the man behind him.</p>		

Table A-1 Silent Hand Signals

AIDS TO CROSSING WATER OBSTACLES

General

1. This Annex describes some methods of improving flotation and using line to cross water obstacles.

Improved Flotation

2. Any item which will float can be used to assist swimmers to float equipment across a water obstacle.

3. Floats should be secured by a long line to each bank so that after being pulled across they can be pulled back and used again.

4. The following are only a few examples of the many items which can be used as aids to flotation:

a. A Single Shelter Sheet or Poncho -

(1) place weapons and equipment together with enough grass or brush to trap a substantial amount of air in the centre of a shelter sheet (or poncho with the hood tied up),

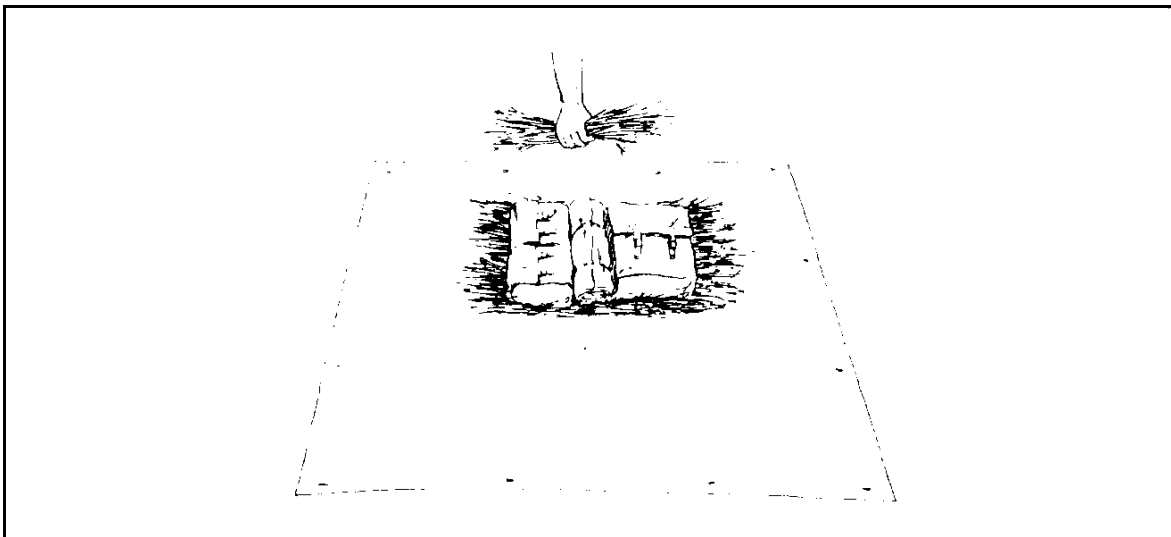

Figure B-1 First Step

- (2) fold the long edges of the sheet together and fasten the clips. Then take a stick 1 metre long, place it along this fastened edge, and roll it up in the sheet until it is tight,

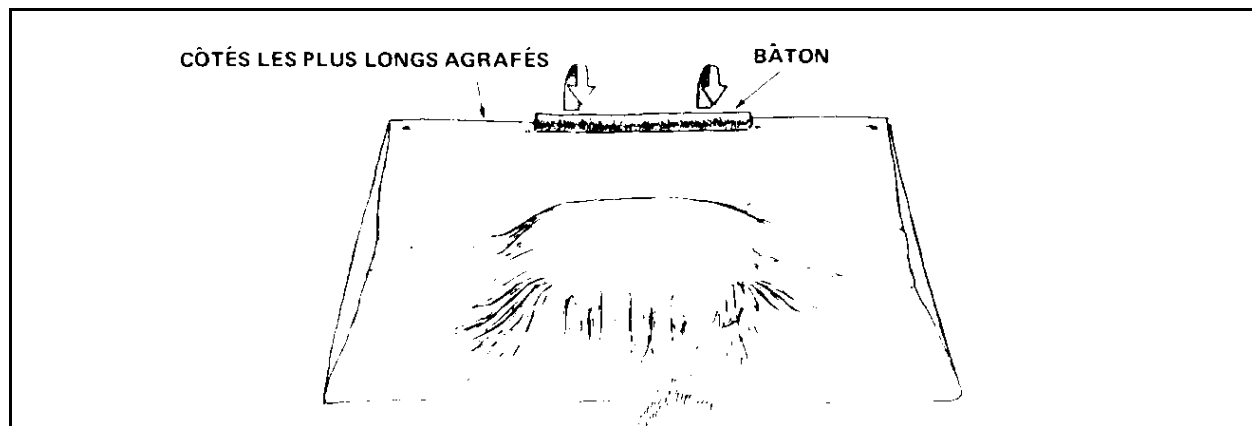

Figure B-2 Second Step

- (3) wind up and tie the ends,

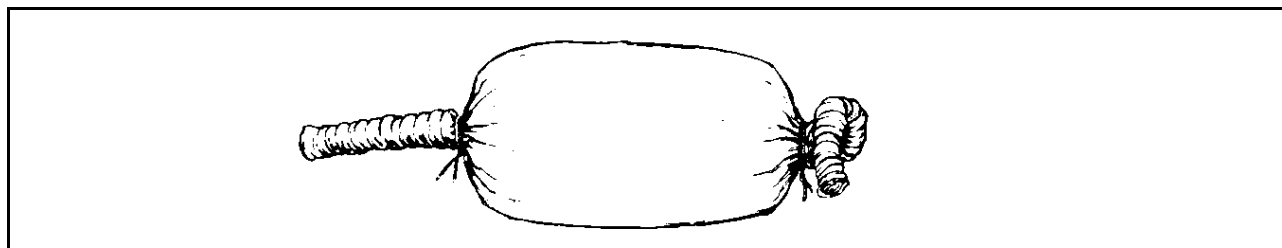

Figure B-3 Third Step

- (4) lash the ends together and tie them round the middle,
(5) attach safety lines and test before using,

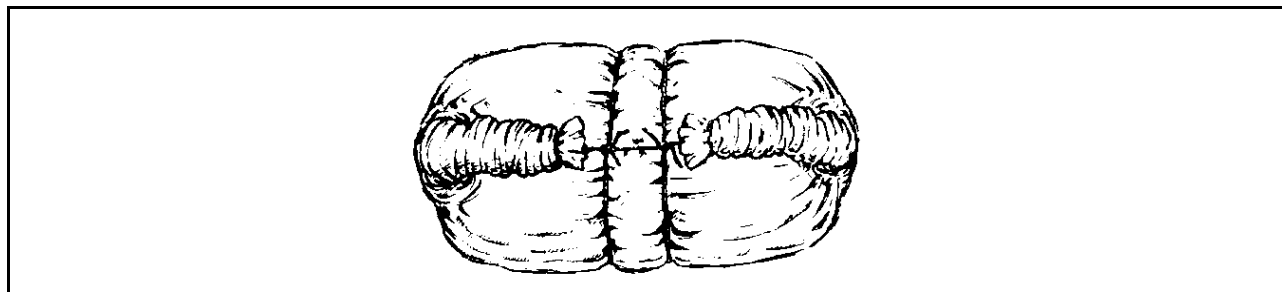

Figure B-4 Fourth Step

- (6) a more watertight float can be made if a second sheet is available. In this case proceed as above, then place the bundle upside down on a second shelter sheet and repeat process;
- b. Water Bags or Packs - Fill packs or waterproof bags with air, or stuff them with grass or brush, and tie securely;
- c. Water Bottles or Coconuts - Six empty water bottles with tops well secured, attached to a belt, and worn upside down, or three coconuts tied together, will keep a non-swimmer afloat;
- d. Bamboo or Nibong Palm - The trunk of the nibong palm or lengths of bamboo lashed together make excellent floats and rafts;
- e. Jerry Cans and Air Beds - Sealed empty Jerry cans and inflatable air beds, if available, make very good floats;
- f. Clothing - Pants or shirts can be tied at the ankles, neck, and wrists, soaked in water and filled with air to assist weak swimmers. The waist can be tied or held together under water by the swimmer (see Figure B-6).



Figure B-5 Leaving the Water With a Float Made From a Waterproof Sheet Wrapped Around Personal Equipment

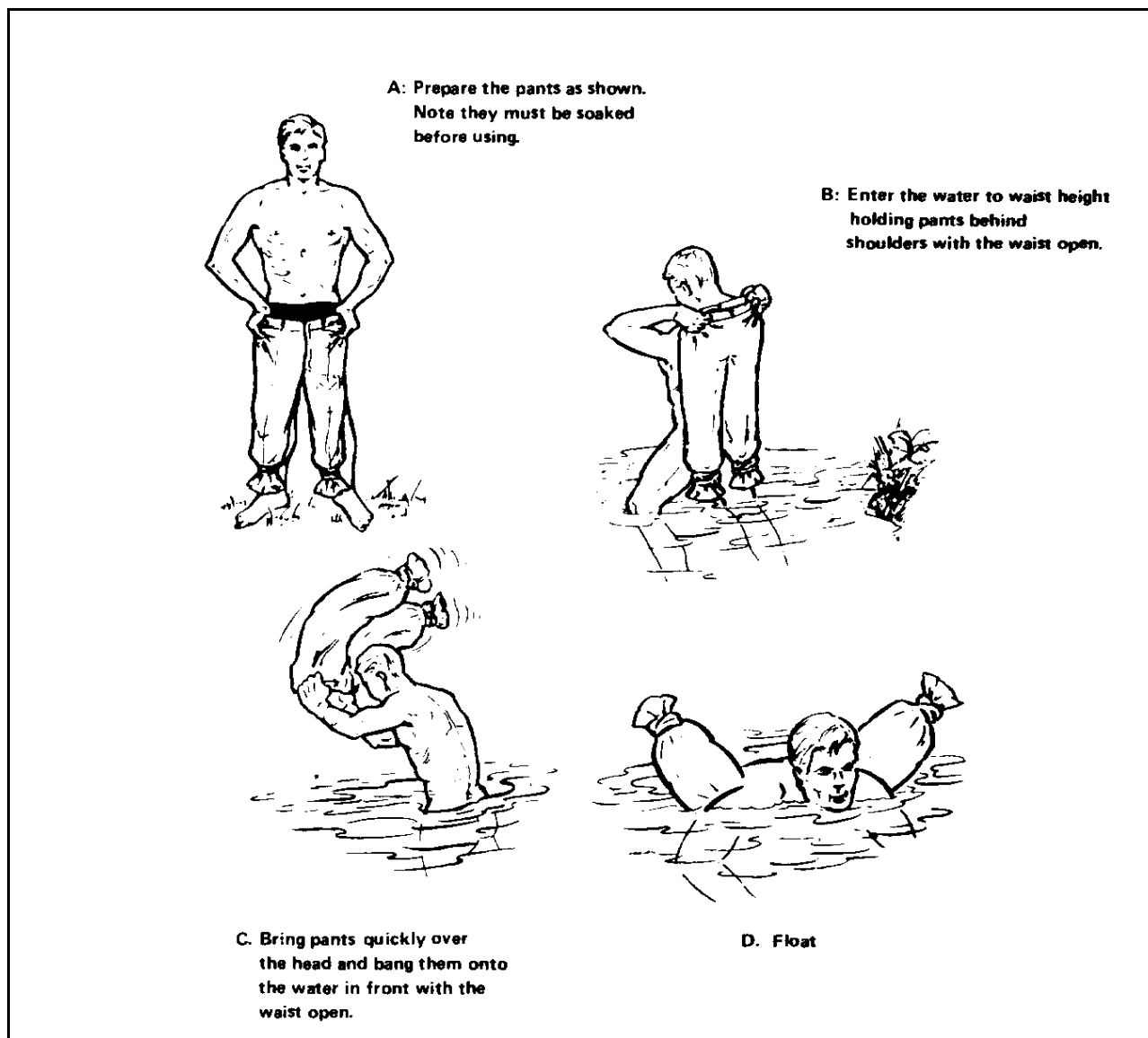

Figure B-6 Individual Flotation - Trouser Method

Use of Line to Cross a Water Obstacle

5. By taking a light line across a water obstacle, a good swimmer can haul across a strong rope which can be secured and tightened to assist others to cross.

6. If there is a swift current, the first swimmer will be unable to make a direct crossing and so must have enough light line for an oblique crossing. He should start upstream so as to land opposite the intended crossing point or he will need to retrace his steps on the far bank after landing. The method adopted will depend on the density of vegetation on both banks as well as enemy interference, etc. The plan of a crossing is shown in Figure B-7 and the use of a "Pendulum" ? to float across men or equipment is shown in Figure B-8.

7. Whenever a rope is used to assist men in the water, it must be stretched as tight as is practicable or they may be dragged below the surface (see Figures B-9 and B-10). It is also important that the rope should be recovered when the last man crosses.

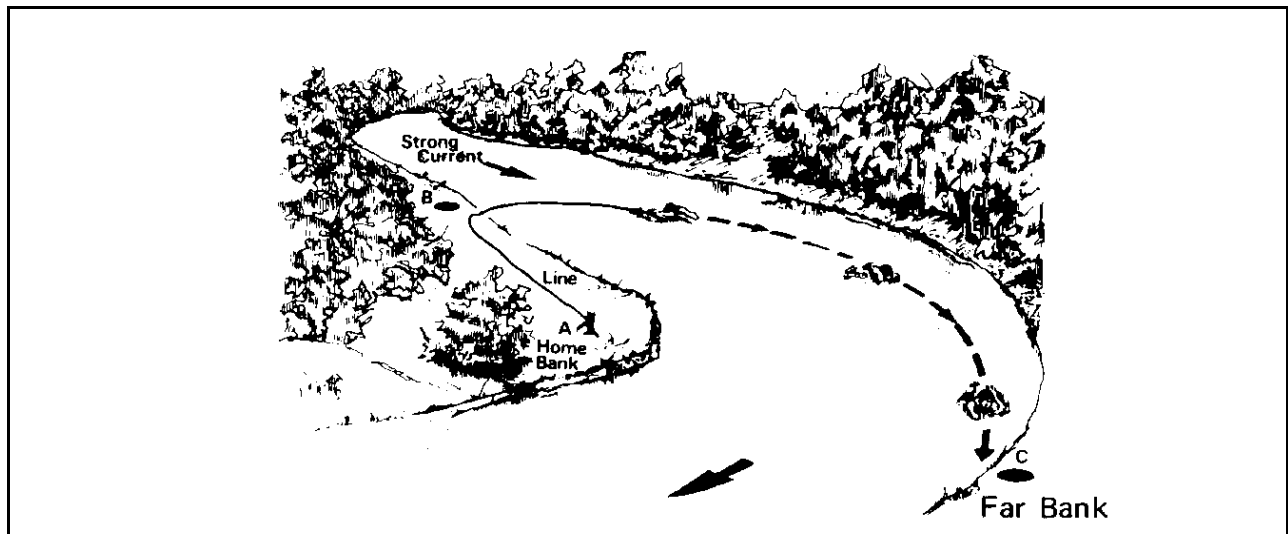

Figure B-7 Taking a Line Across a Water Obstacle

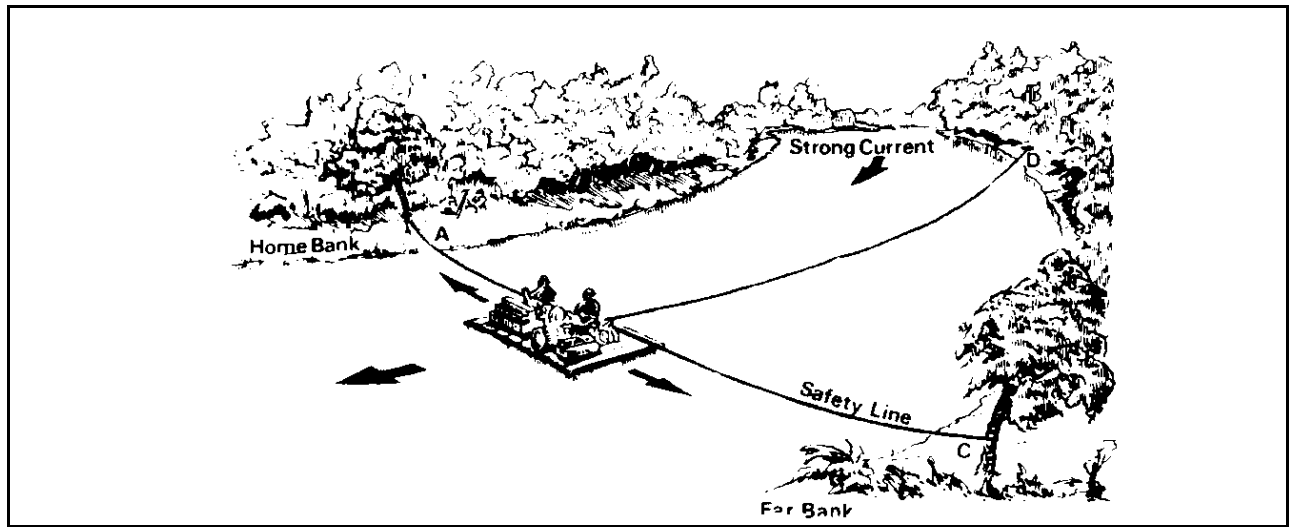

Figure B-8 Crossing a Water Obstacle - Pendulum Method



Figure B-9 Crossing a Jungle River Assisted by a Rope

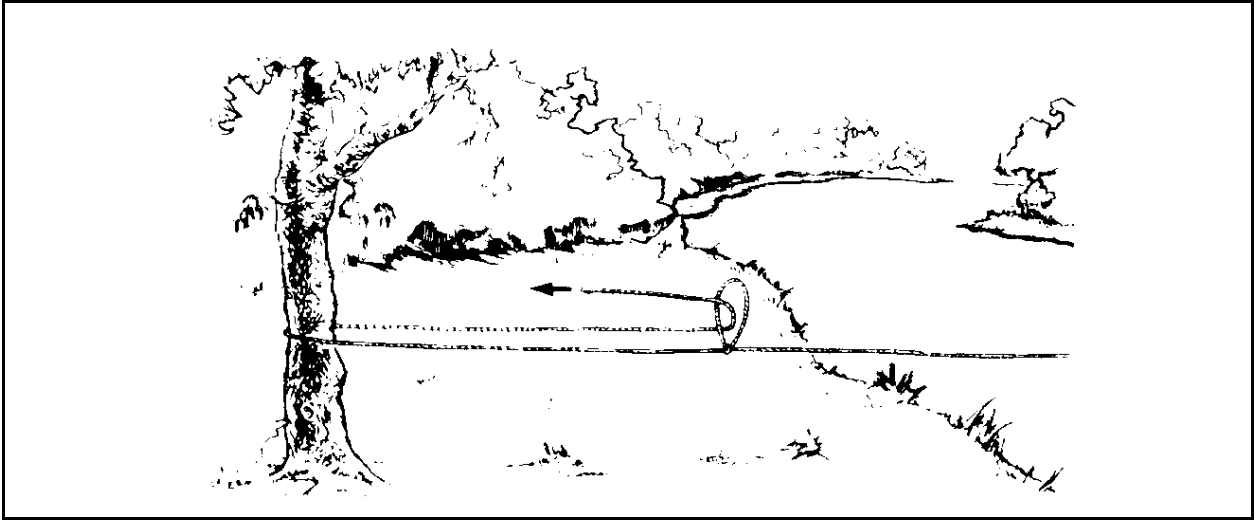

Figure B-10 Method of Tightening a Rope

SUGGESTED LOADS**INDIVIDUAL SURVIVAL KIT**

Serial	Item	Remarks
1	1 Plastic Water Bag	
2	100 Sterilizing Tablets	In light waterproof container
3	100 Multivite Tablets	
4	24 Chloroquine-Primaquine Tablets	
5	50 gms salt	
6	1 magnifying glass	For starting fire
7	10 assorted fishhooks	Protected by plastic Safety pins for disarming booby-traps
8	5 suture needles	
9	5 safety pins	
10	5 lighter flints	
11	1 Scalpel Blade	
12	1 Fishing Net	Used for erecting shelters, communications or tripcord,mending clothes, fishing, trapping, stitching wounds.
13	15 metres of Fishing Line	
14	\$ 20. in small denomination local currency notes	In plastic bag
15	Snake Bite Kit	

NOTE: Total weight is approximately 225 gms

Table C-1 Suggested Items for Inclusion in Individual Survival Kit

INDIVIDUAL LOAD

1. The individual should carry the following in addition to normal items not mentioned.

Serial	Items	Remarks
1	Waterproof Luminous watch	Secured by green nylon cord
2	10 Spare buttons	Sewn on inside of hip pocket flap
3	Identification (ID) discs	Taped and tied with green nylon cord
4	Jungle boots	Green nylon cord substituted for laces
5	2 escape compasses 1 escape map 1 hacksaw blade	Sewn into clothing
6	Silva compass, signal mirror	Secured by green nylon cord
7	Survival Pack, Individual Medical Pack	
8	35 metres green nylon cord	
9	Anti-malaria pills, Water sterilizing pills	
10	Jungle knife, sheath, and sharpening stone.	
11	Cooking pot with lid	
12	Insect repellent	
13	Waterbag	
14	Flashlight	
15	A Spring-operated Fire Bow	

Section or Platoon HQ Load

2. The following items are suggested for platoon HQ:

Serial	Items	Remarks
1	100 metres green nylon cord	Ends to be spliced
2	Air panels	Sew over long edge so it can be used as a stretcher.